

EZ Tube® CONNECT CIRCLE 5FT

PRODUCT CATEGORY: EZ FABRIC DISPLAYS

PRODUCT CODE: EZCNCT-CIR5



On frame



On graphic



PRODUCT DESCRIPTION

Modular has officially met tube frames! EZ Tube® Connect modular tube display system lets you configure multiple shapes, sizes and frames. Circle frames are the newest edition to the EZ Tube® Connect family. Choose from 5ft or 7ft diameter circles to use individually or in pre-designed or custom configurations.

DISPLAY DIMENSIONS	60"W x 72"H x 18.75"D
GRAPHIC SIZE	61"W x 61"H

GRAPHIC MATERIAL

Stretch Fabric

GRAPHIC FINISHING

Sewn around perimeter with zipper on the bottom

DISPLAY CONSTRUCTION

34mm Aluminum Tubing

SHIPPING WEIGHTS & DIMENSIONS

Shipping Weight	9 lbs (frame and graphics)
Shipping Dimensions	48"W x 8"H x 8"D

LARGE QUANTITY FREIGHT

Freight Shipping	48 boxes per 48"L x 40"W x 43"H skid
Freight Weight	768 lbs (frames & graphics)

GRAPHIC TURN AROUND TIME

2 business days after proof approval

AVAILABILITY	Pacific Fulfillment Center
--------------	----------------------------



Single foot connection

Foot Dimensions:
3 1/8" x 18 3/4"



Optional 36" Silverbag

Inside dimensions:
39"W x 10.5"H x 3"D

EZ Tube® CONNECT CIRCLE 5FT

PRODUCT CATEGORY: EZ FABRIC DISPLAYS

PRODUCT CODE: EZCNCT-CIR5

PARTS LIST



Male - Male Curved Tube
(qty 2)



Male - Female Curved Tube
(qty 2)

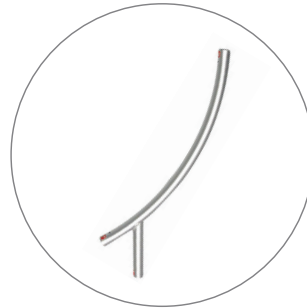

Bottom Tubes for Legs
(qty 2)



Leg Tube
(qty 2)



Single Foot (34mm)
(qty 2)



Travel Bag
(qty 1)

EZ Tube® CONNECT CIRCLE 5FT

PRODUCT CATEGORY: EZ FABRIC DISPLAYS

PRODUCT CODE: EZCNCT-CIR5

INSTRUCTIONS

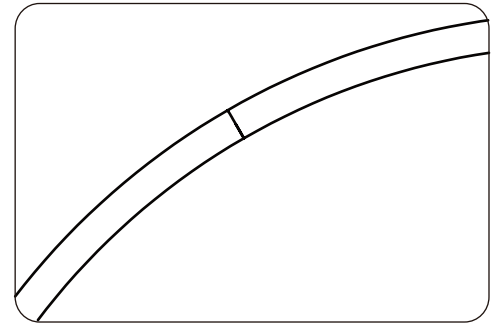
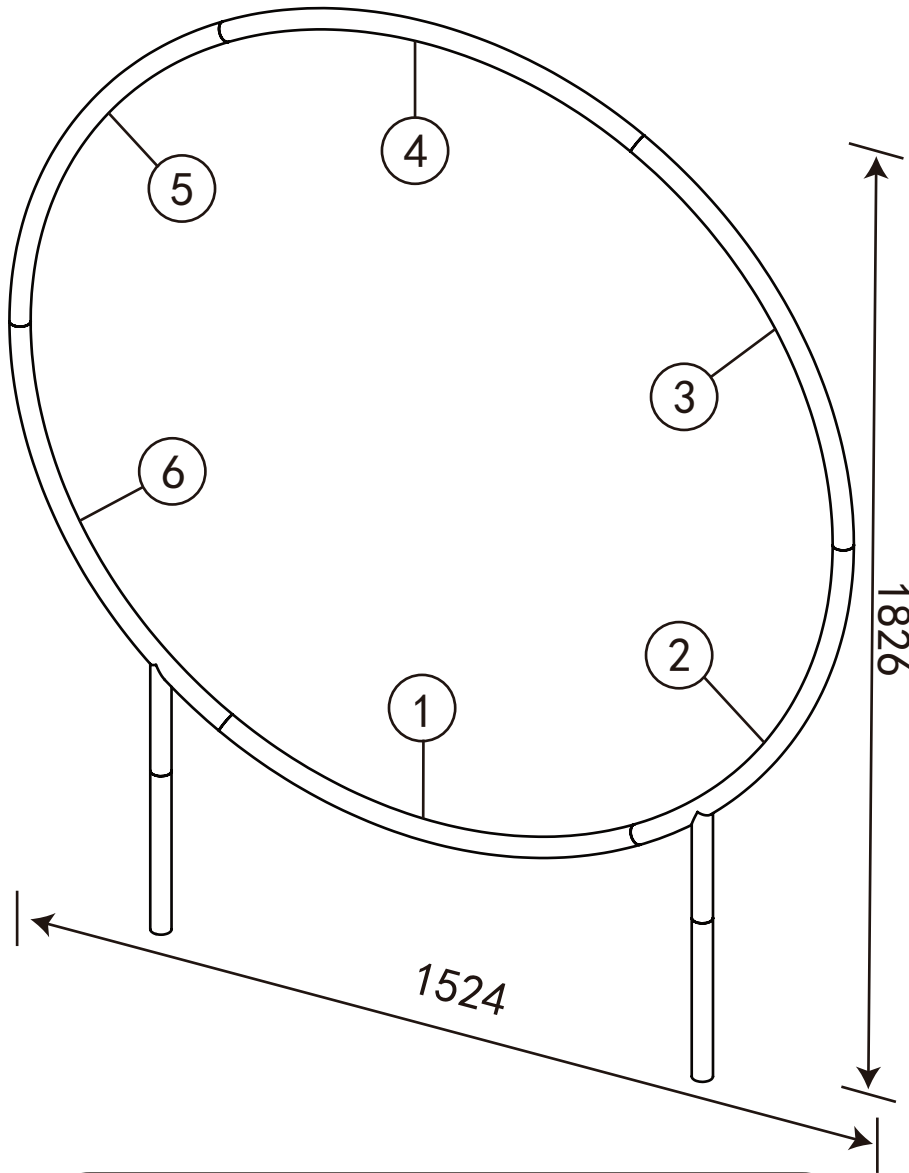

34-diameter tube, round stand,
insert connection

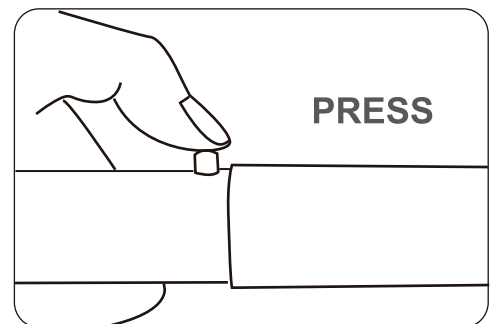
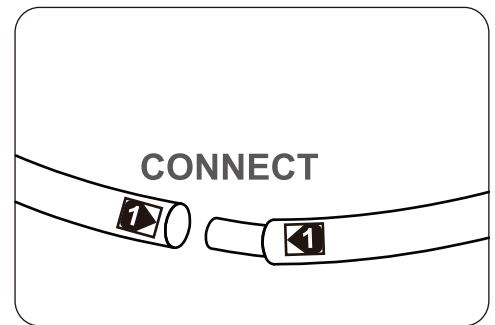

If can't snap when dismantle the frame, Pls push the tube forwardly, then push again.

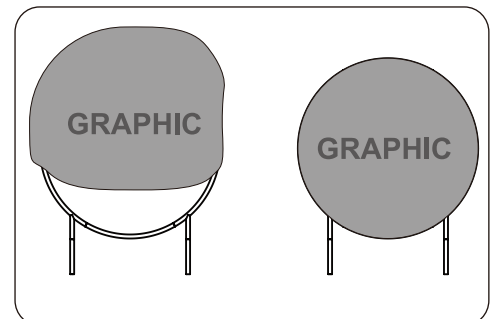
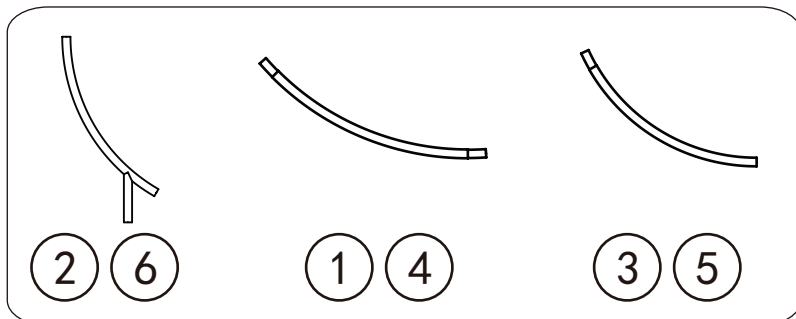

EZ Tube® CONNECT CIRCLE 7FT

PRODUCT CATEGORY: EZ FABRIC DISPLAYS

PRODUCT CODE: EZCNCT-CIR7



On frame



On graphic

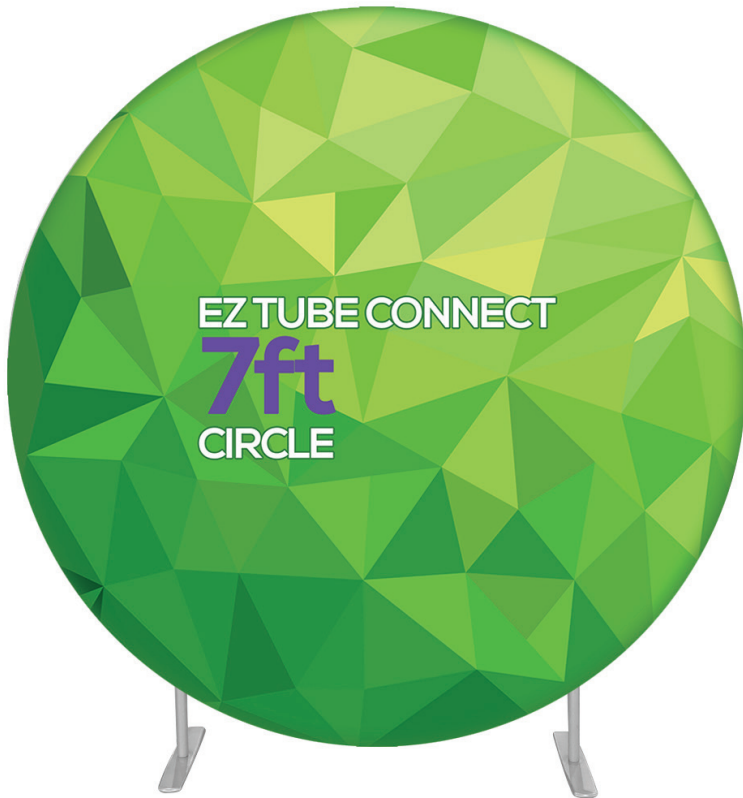

PRODUCT DESCRIPTION

Modular has officially met tube frames! EZ Tube® Connect modular tube display system lets you configure multiple shapes, sizes and frames. Circle frames are the newest edition to the EZ Tube® Connect family. Choose from 5ft or 7ft diameter circles to use individually or in pre-designed or custom configurations.

DISPLAY DIMENSIONS	84"W x 85.75"H x 18.75"D
GRAPHIC SIZE	84.75"W x 84.75"H

GRAPHIC MATERIAL

Stretch Fabric

GRAPHIC FINISHING

Sewn around perimeter with zipper on the bottom

DISPLAY CONSTRUCTION

34mm Aluminum Tubing

SHIPPING WEIGHTS & DIMENSIONS

Shipping Weight	10 lbs (frame and graphics)
Shipping Dimensions	42"W x 11"H x 6"D

LARGE QUANTITY FREIGHT

Freight Shipping	48 boxes per 48"L x 40"W x 43"H skid
Freight Weight	768 lbs (frames & graphics)

GRAPHIC TURN AROUND TIME

2 business days after proof approval

AVAILABILITY	Pacific Fulfillment Center
--------------	----------------------------

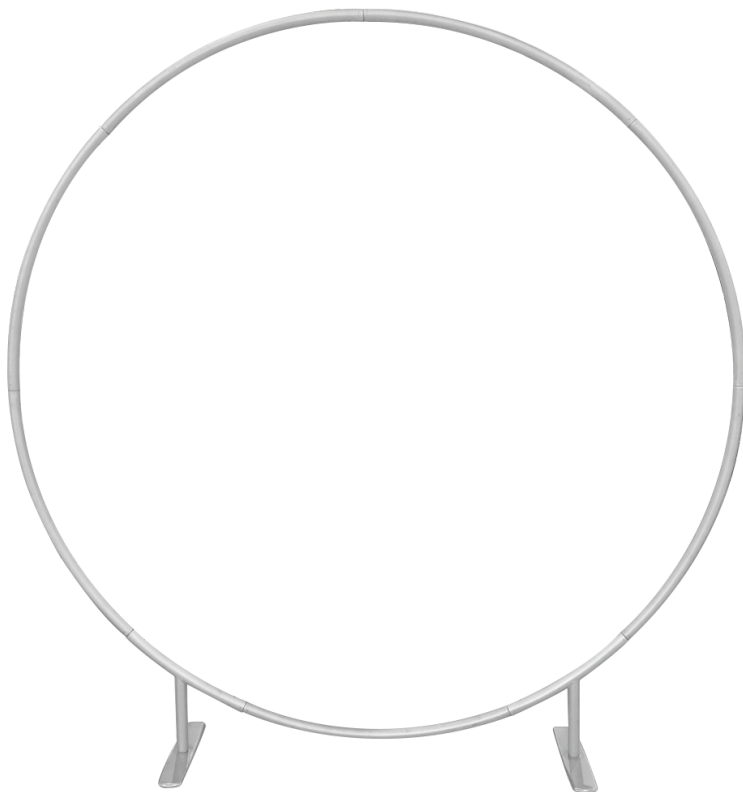

Single foot connection

Foot Dimensions:
3 1/8" x 18 3/4"



Optional 36" Silverbag

Inside dimensions:
39"W x 10.5"H x 3"D

EZ Tube® CONNECT CIRCLE 7FT

PRODUCT CATEGORY: EZ FABRIC DISPLAYS

PRODUCT CODE: EZCNCT-CIR7

PARTS LIST



Male - Male Curved Tube
(qty 2)

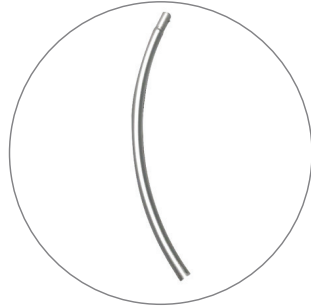

Male - Female Curved Tube
(qty 5)



Bottom Tubes for Legs
(qty 2)



Single Foot (34mm)
(qty 2)



Travel Bag
(qty 1)

EZ Tube® CONNECT CIRCLE 7FT

PRODUCT CATEGORY: EZ FABRIC DISPLAYS

PRODUCT CODE: EZCNCT-CIR7

INSTRUCTIONS

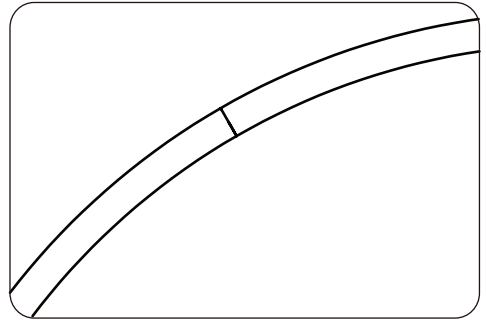
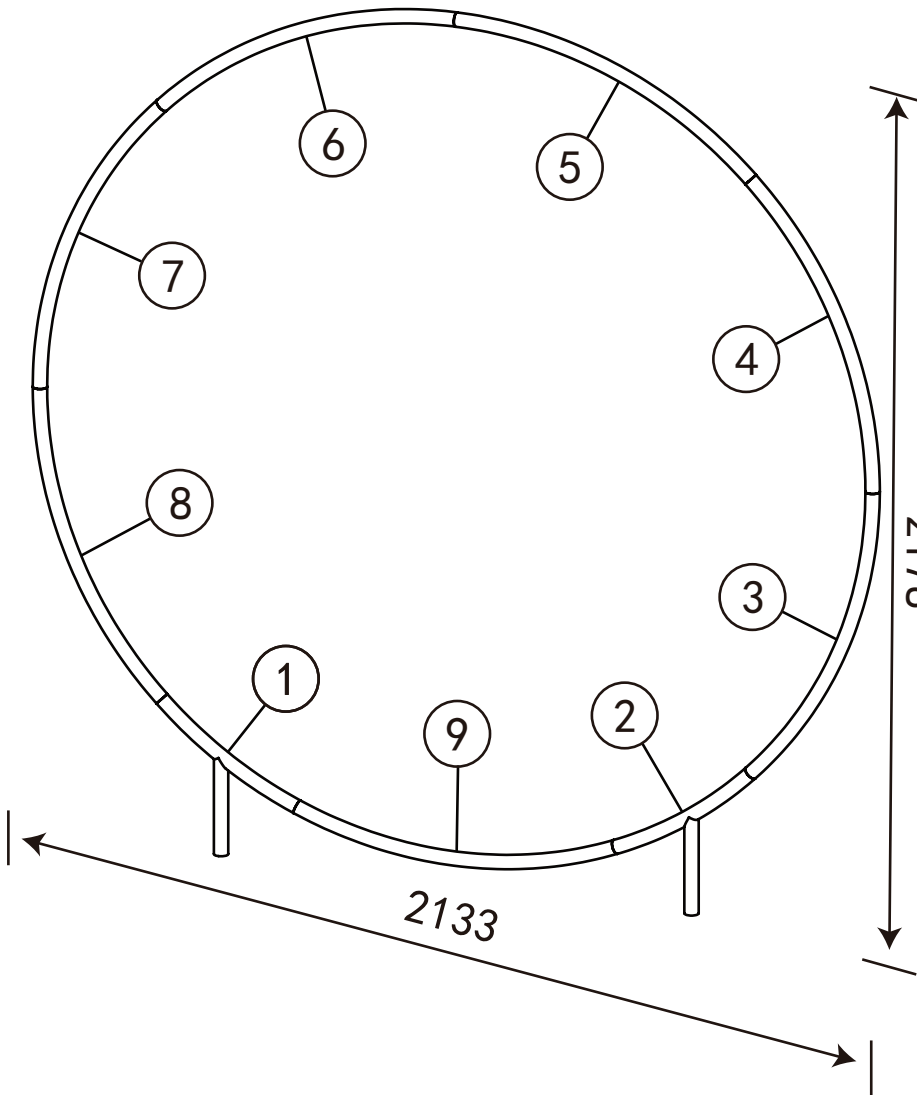

34-diameter tube, round stand,
insert connection

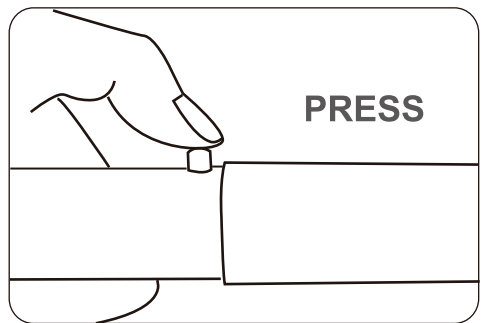
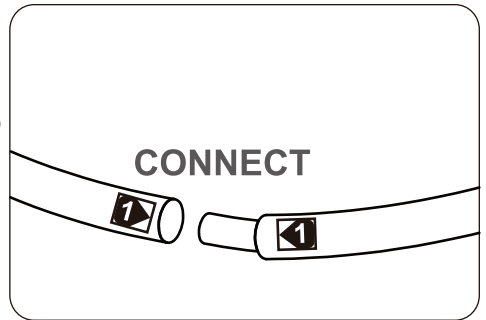

If can't snap when dismantle the frame, Pls push the
tube forwardly, then push again.

