

MODify Single Sided Kit 03

MODify™ is a one-of-a-kind Modular Merchandising System that is made up of interchangeable fixtures and accessories that can be easily assembled, disassembled, and rearranged to create a variety of different display configurations. The MODify system incorporates SEG push-fit fabric graphics that enable you to brand, promote and merchandise with ease.

MODify Single Sided Kit 03 features two slatwall panels (right/left) and one center graphic panel. Customize your kit with fixtures such as shelves, waterfalls and hooks, or furniture like tables and risers. The center SEG push-fit graphic panel can be effortlessly replaced at any time, allowing you to keep your display up-to-date and on-trend.



MODify Single Sided Kits should be mounted to a wall or structure for safety and stability.

We are continually improving and modifying our product range and reserve the right to vary the specifications without prior notice. All dimensions and weights quoted are approximate and we accept no responsibility for variance. E&OE. See Graphic Templates for graphic bleed specifications

features and benefits:

Base Kit includes:

- Frame, slatwall, shelf and base colors in kit are all the same, your choice of all white, black, or silver
- Heavy-duty aluminum frame, steel base
- Steel, slotted uprights
- Left & right 35"W x 96"H slatwall panels
- Center graphic panel 35"W x 96"H
- Non-rolling base
- Display is easy to assemble and install
- Lifetime hardware warranty against manufacturer defects

Optional Accessories Include:

- Towel bars.
- Faceout bars
- Waterfalls
- U bars
- Slatwall hooks
- Shelves

dimensions:

Hardware

Assembled unit:

110"W x 96"H x 20"D
2794mm(w) x 2438.4mm(h) x 520.7mm(d)

Approximate Weight:
226 lbs / 102.512 kg

Shipping

Packing case(s):
1 Box

Shipping dimensions:
(72" L x 20" H x 24" D)
1828.8mm(l) x 508mm(h) x 609.6mm(d)

Approximate shipping weight:
282 lbs / 127.913 kg

additional information:

Graphics

Graphic material: Dye-sublimated fabric

See graphic templates for graphic sizes.

Refer to related graphic templates for more information Visit:

<https://www.theexhibitorshandbook.com/downloads/download-graphic-templates>
or click here

Powder coat color options:



Wood laminate color options:

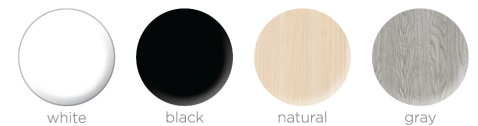

MODify Accessories

All Accessories available in white, black, or silver

Slotwall Accessories

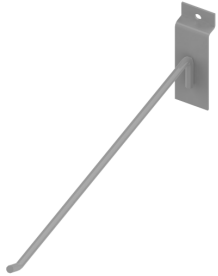

MFY-SLT-HK
4", 6", 8", 10" & 12"

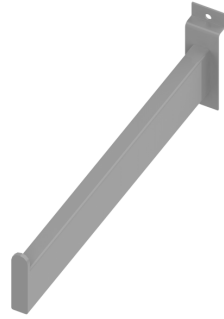

MFY-SLT-FC
6", 8", 10" & 12"

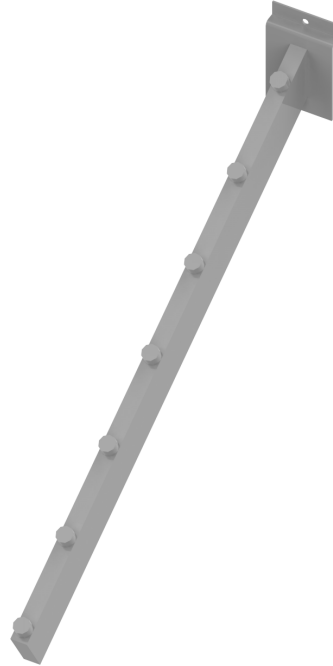

MFY-SLT-WTR-16-7

U-Bar Accessories

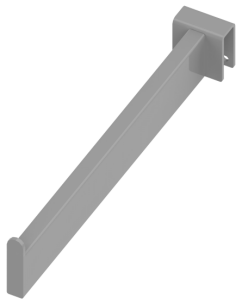

MFY-TWL-FC
6", 8" & 10"

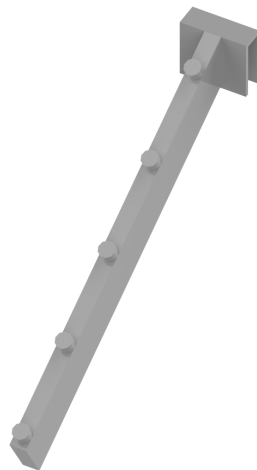

MFY-UBR-FC
6", 8" & 10"

Shelf and Hanger Bars

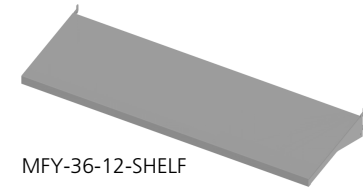

MFY-36-12-SHELF

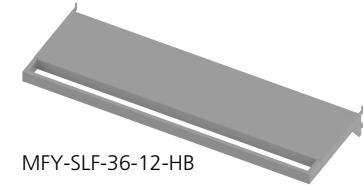

MFY-SLF-36-12-HB

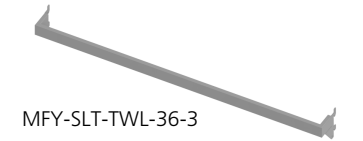

MFY-SLT-TWL-36-3



MFY-UBR-36-12

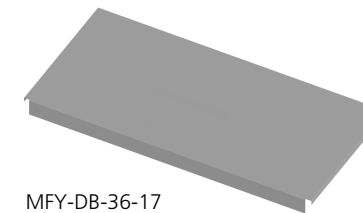

MFY-DB-36-17

How to Apply & Remove Graphics

Installation and removal of SEG graphics is easy!

Installation: Push the SEG bead into each corner of the frame (1-4) with your thumb, then push the SEG bead into the middle of the run (5-8) and work your way around the perimeter of the frame until all beading is pushed in properly; if necessary, go around the perimeter again to ensure beading is secure in the extrusion profile.

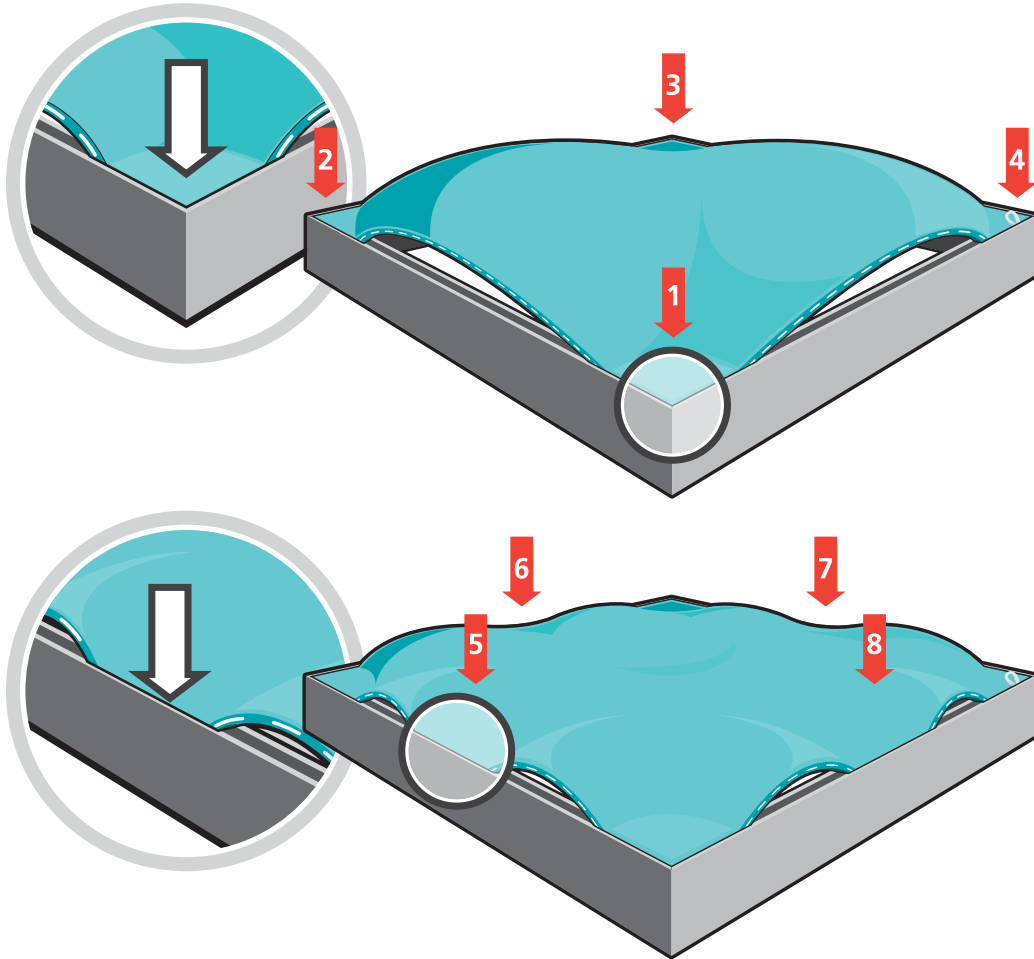





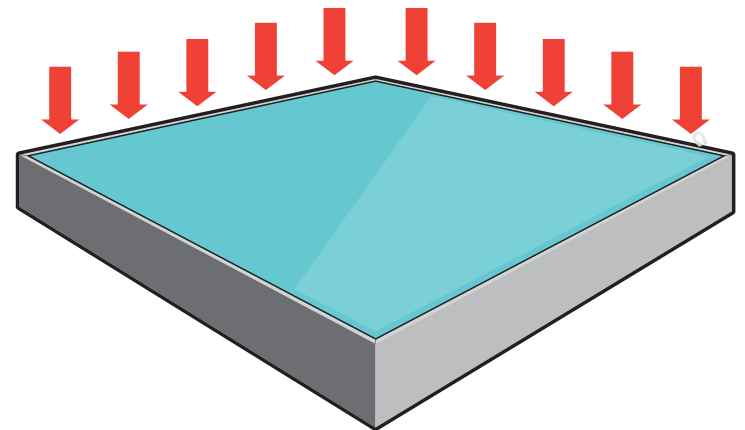

Note: Keep the set up area clean by using a drop cloth, washing hands before set-up or by wearing gloves.

Removal: Use the pull tab located on the graphic and gently pull the graphic from the frame, going around the perimeter.



Graphics Storage & Care

Graphics should be folded with the graphic facing inward and stored in a zip lock /sealable plastic bag. Spot clean by wiping with a damp white cloth. If washing is necessary, use a commercial size front-loading washing machine, gentle cycle with cool water. Line dry flat. Dry cleaning is NOT recommended to prevent shrinkage.

QTY	IMAGE	DESCRIPTION
4		3/8-16 x 2.5" L bolt
1		2350MM (92.52in) LEFT UPRIGHT
2		2350MM (92.52in) MIDDLE UPRIGHT
1		2350MM (92.52in) RIGHT UPRIGHT
4		2250MM (88.58in) OF SVC EXTRUSION
4		512MM (20.16in) SUPPORT LEG

SETUP INSTRUCTIONS

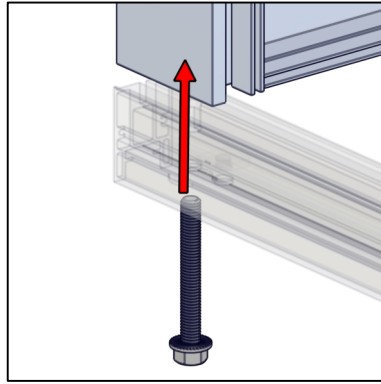
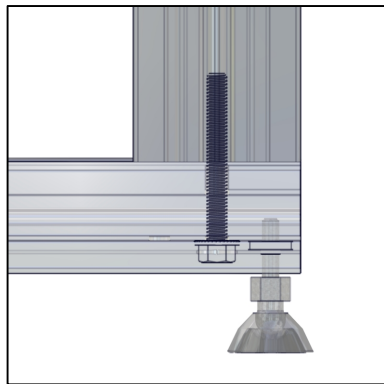

MFY-BOLT-375-16-2.5

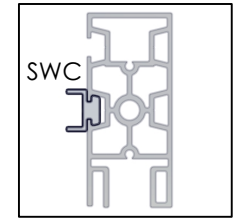
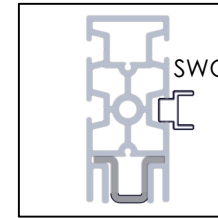
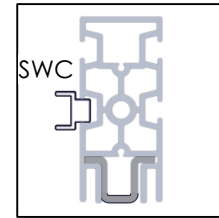
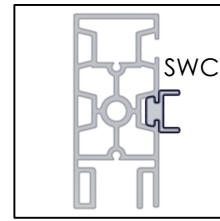

LEFT UPRIGHT

SVC PRE-INSTALLED

MIDDLE UPRIGHT

SVC

MIDDLE UPRIGHT

SVC PRE-INSTALLED

SVC

SVC

RIGHT UPRIGHT

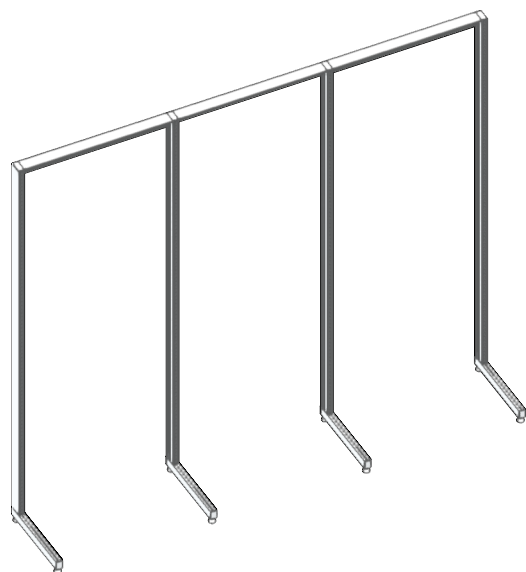

STEP 1

BOLT UPRIGHTS TO FEET TOGETHER

QTY	IMAGE	DESCRIPTION
2		883MM (34.7in) OF SWC EXTRUSION
3		883MM (34.7in) OF SINGLE SIDED SEG EXTRUSION -WITH CAM LOCKS BOTH ENDS
6		WALL BRACKET

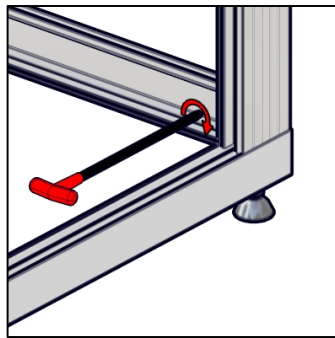

CROSS BRACE SITS ON SUPPORT LEG

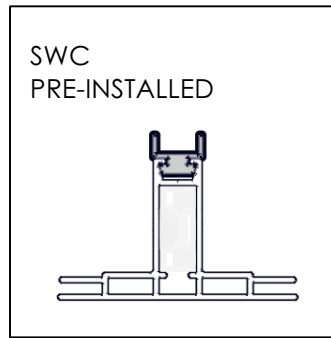

SWC PRE-INSTALLED
SLOT WALL TOP CHANNEL

SETUP INSTRUCTIONS

STEP 5

* LOCK TOP CROSS BRACE AND PLACE END CAPS TO ALIGN WALL BRACKETS (TEMPORARY INSTALLED)

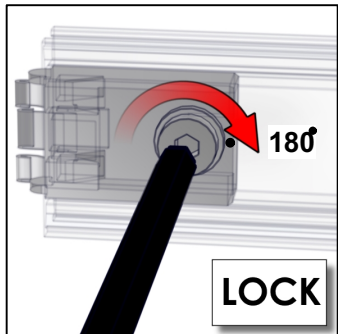

IMPORTANT!
MAKE A HALF TURN TO LOCK EXTRUSIONS

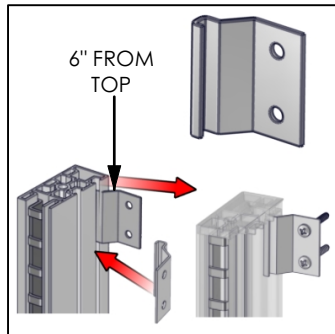

WALL MOUNT CLIPS

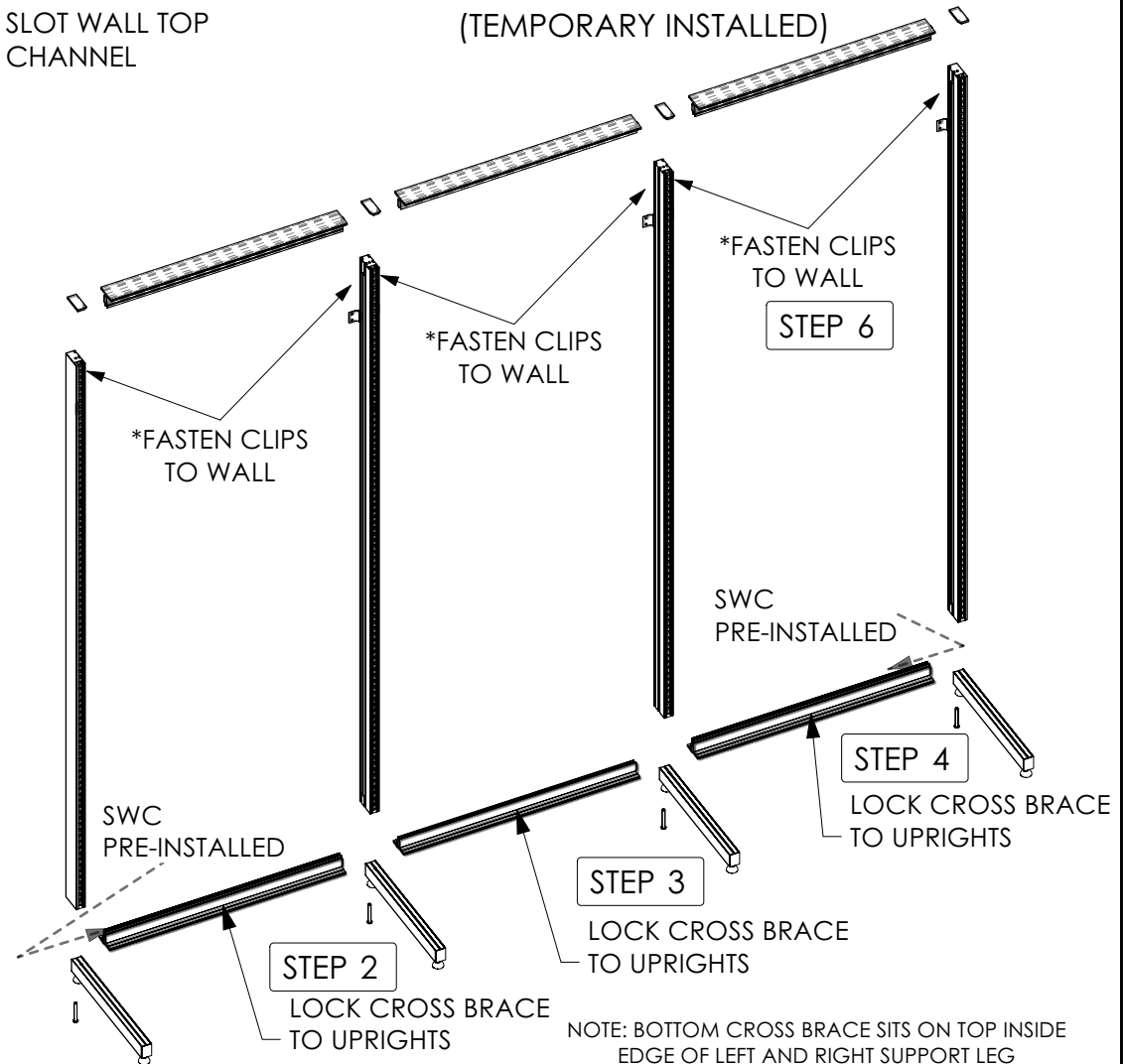
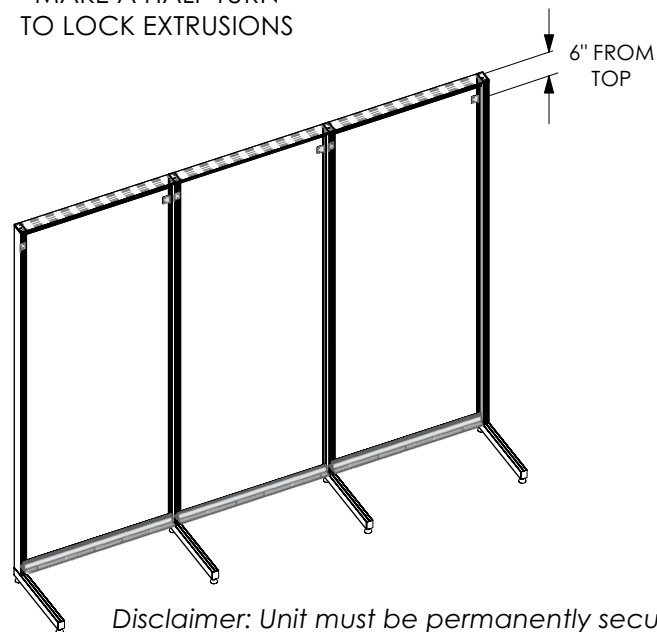

Disclaimer: Unit must be permanently secured and fastened to wall or other structure for stability.

QTY	IMAGE	DESCRIPTION
2		883MM (34.76in) OF SINGLE SIDED SEG EXTRUSION -WITH CAM LOCKS BOTH ENDS
14		879MM (34.61in) LENGTH OF SLOTWALL EXTRUSION
1		879MM (34.61in) LENGTH OF SLOTWALL EXTRUSION -WITH 27.75MM BOTTOM CUT
1		883MM (34.76in) OF SWC EXTRUSION
1		7MM SEG PLASTIC END CAP FOR 830 EXTRUSION
1		7MM SEG PLASTIC END CAP FOR 831 EXTRUSION

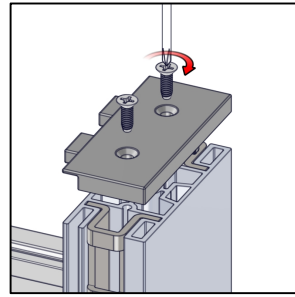

LOOSEN END CAP TO ATTACH TOP CROSS BRACE

SETUP INSTRUCTIONS

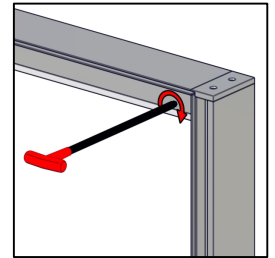

STEP 7

* REMOVE TOP CROSS BRACE AND END CAPS (TEMPORARY INSTALLED)

STEP 8

SLOTWALL EXTRUSION STACK 005-879

STEP 9

LOCK CROSS BRACE TO UPRIGHTS AND PLACE END CAPS

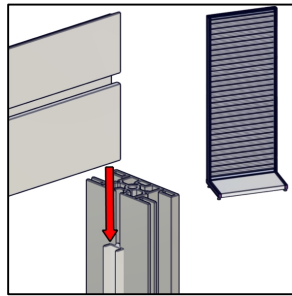
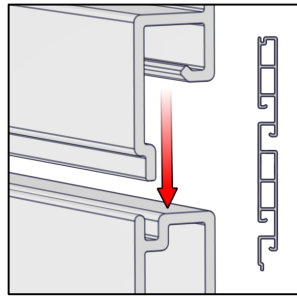

SLOTWALL 005

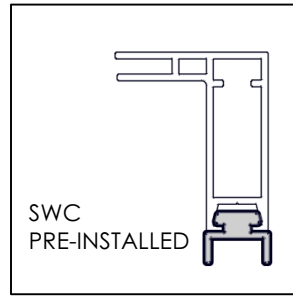





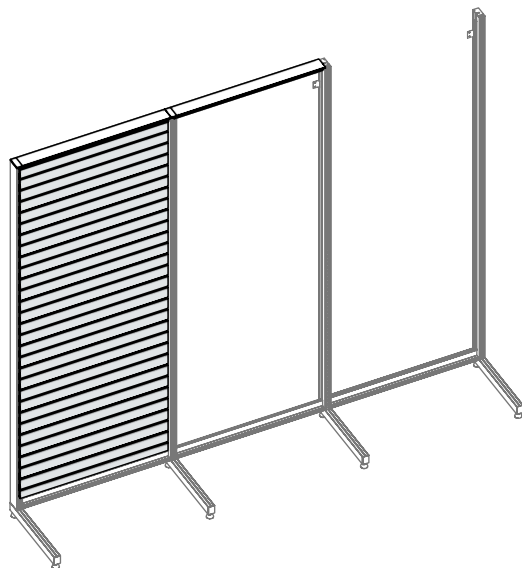
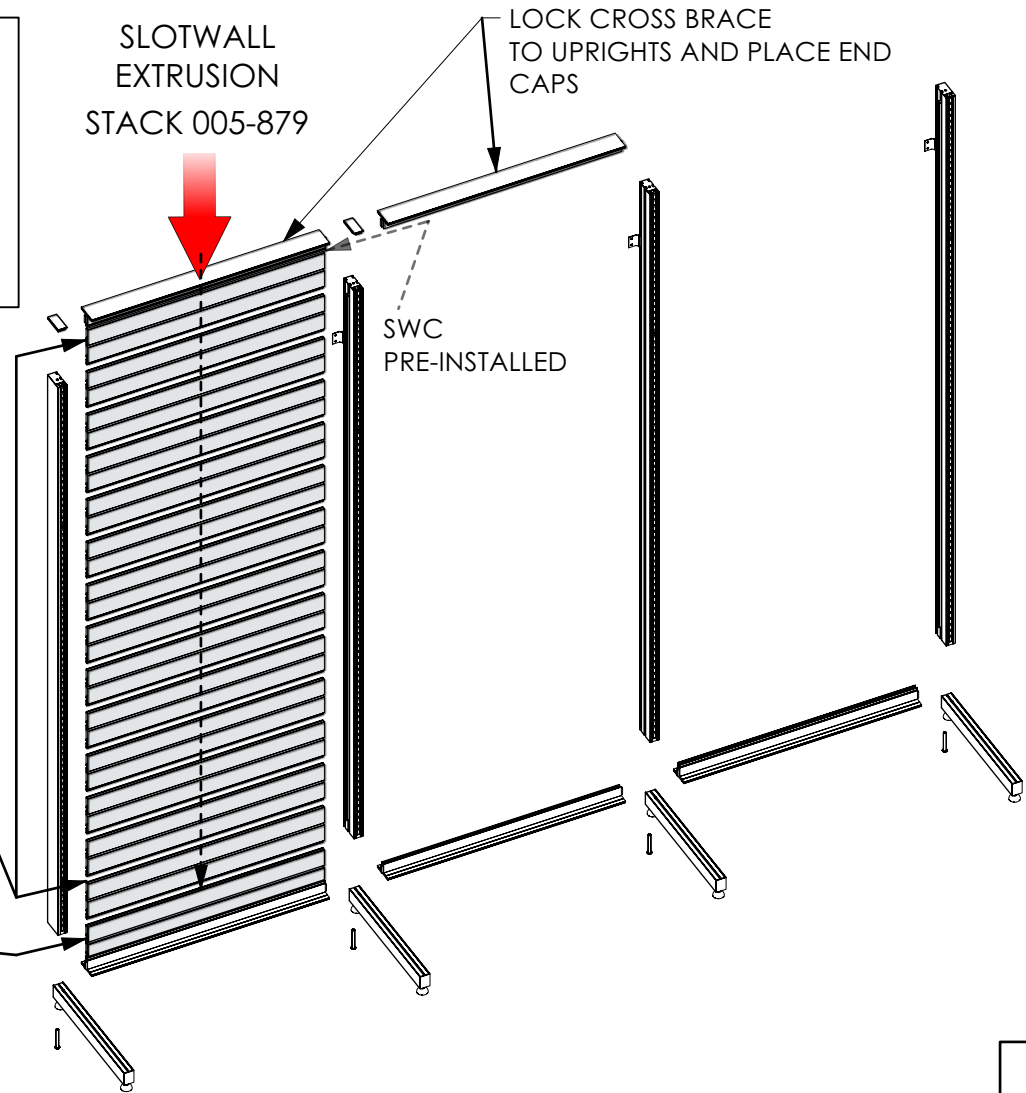

SWC PRE-INSTALLED

SLOT WALL BOTTOM CHANNEL



SLOTWALL

BOTTOM CUT SLOTWALL

14		879MM (34.61in) LENGTH OF SLOTWALL EXTRUSION
1		879MM (34.61in) LENGTH OF SLOTWALL EXTRUSION -WITH 27.75MM BOTTOM CUT
1		883MM (34.76in) OF SWC EXTRUSION
1		883MM (34.76in) OF SINGLE SIDED SEG EXTRUSION -WITH CAM LOCKS BOTH ENDS
1		7MM SEG PLASTIC END CAP FOR 831 EXTRUSION
1		7MM SEG PLASTIC END CAP FOR 830 EXTRUSION

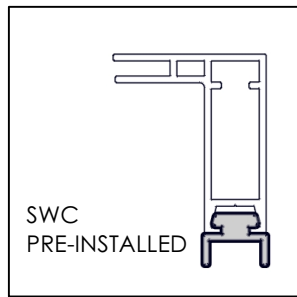

SLOT WALL BOTTOM CHANNEL

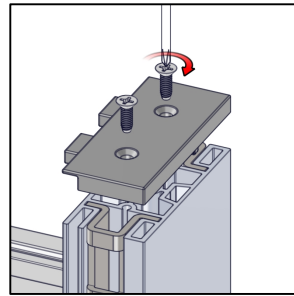

STEP 11

LOCK CROSS BRACE TO UPRIGHTS AND PLACE END CAPS

SETUP INSTRUCTIONS

STEP 10

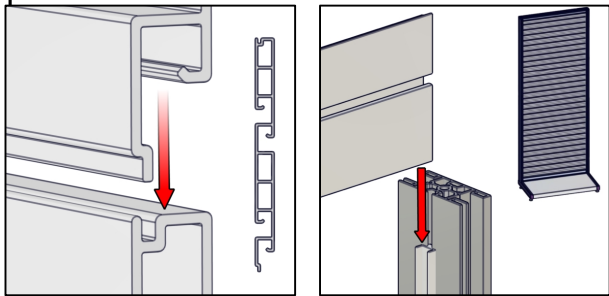
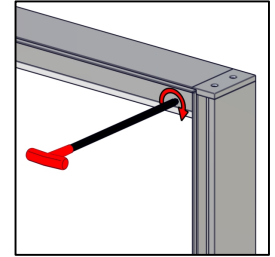

SLOTWALL EXTRUSION STACK 005-879

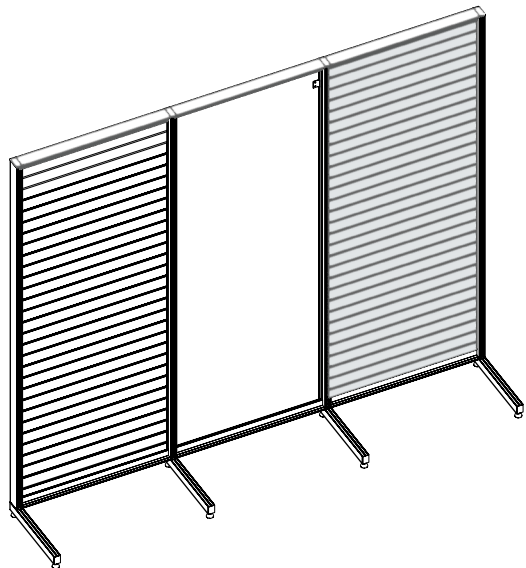
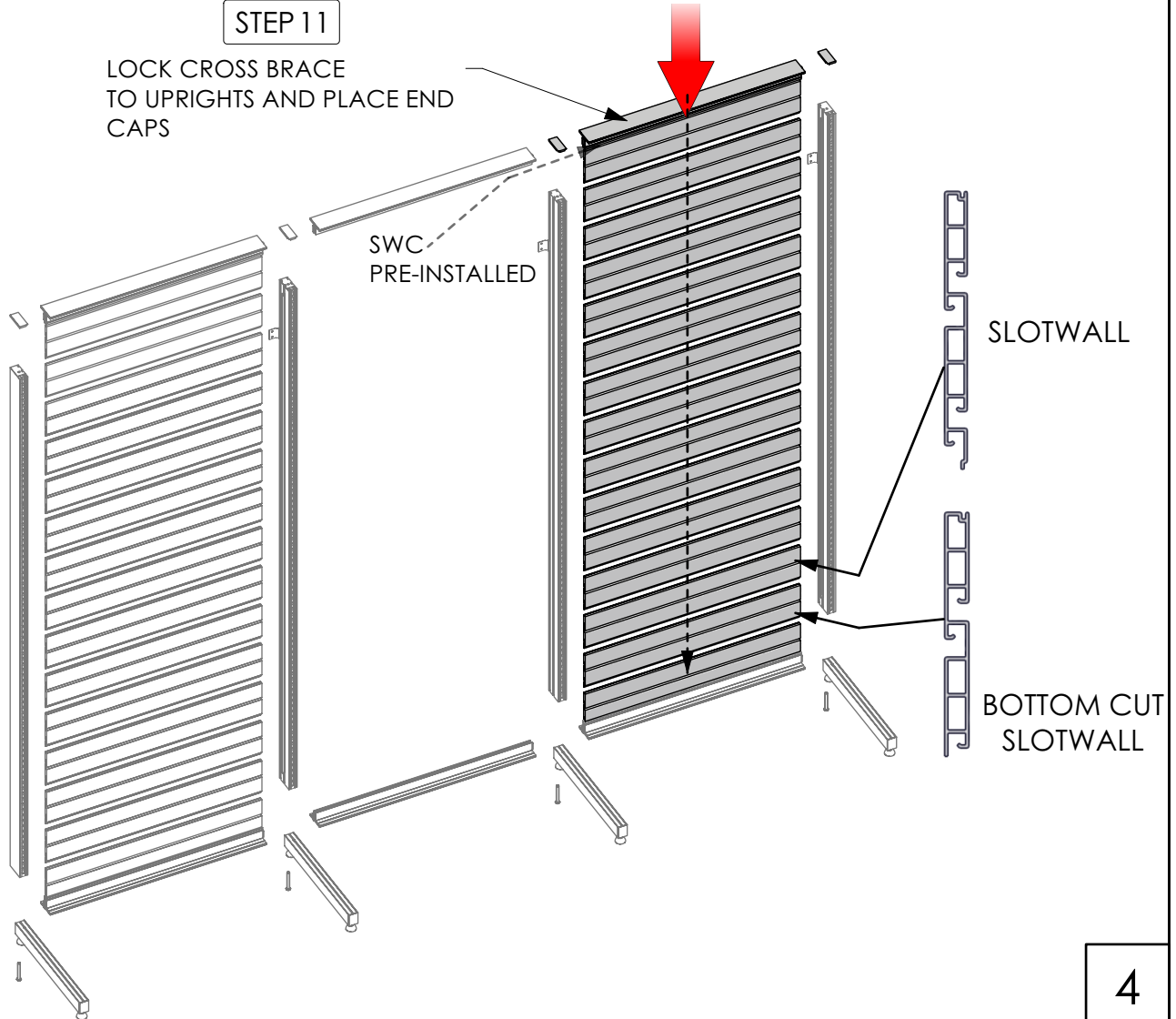

SLOTWALL 005



SETUP INSTRUCTIONS

QTY	IMAGE	DESCRIPTION
3		36in WIDE X 17.25in DEEP - DROP-IN BASE PAN
1		(39.26 w X 96.61 h total size) 35.26 w X 92.61 h finish size, Dye-sub print on Eclipse Blockout Stretch, single sided, sewn with FCE-2 silicone beading around perimeter & pull tab in bottom right corner (WITH 1/4" NOTCH LEFT & RIGHT BOTTOM HORIZONTAL SIDE CORNERS)

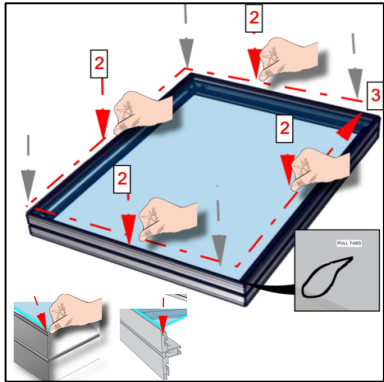

THEN PRESS ALONG THE PERIMETER EDGE

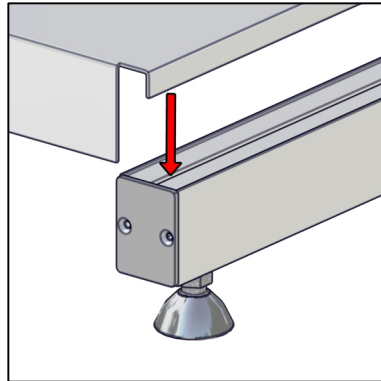



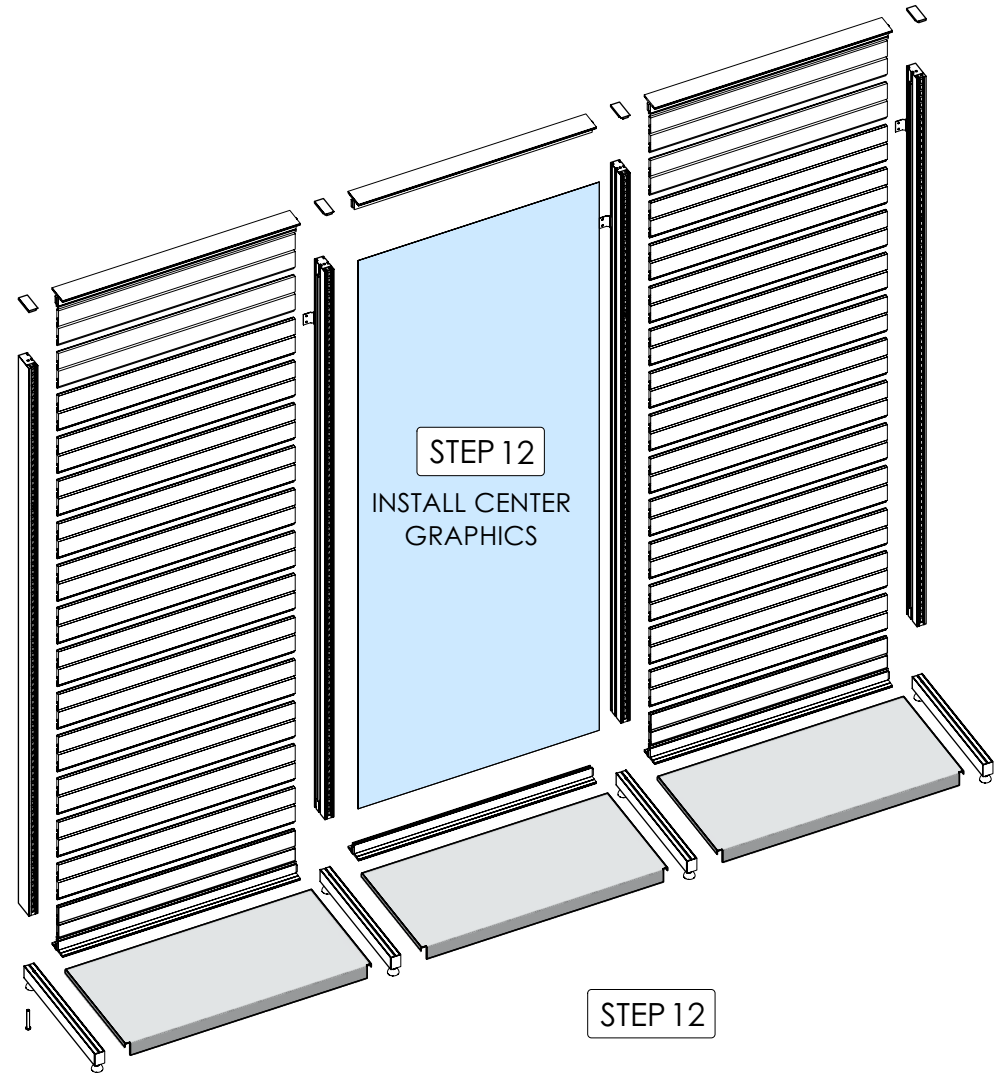



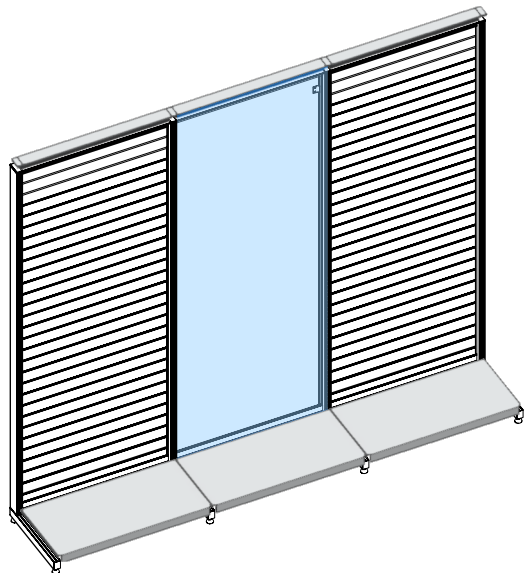







MFY-36-17-BASE-PAN



PLACE BASE PAN IN GROOVE(FOOT)



Kit Hardware BOM

ITEM	COMPONENTS	QTY	DESCRIPTION
	004-883	4	883MM (34.76in) OF SWC EXTRUSION
	004-2250	4	2250MM (88.58in) OF SWC EXTRUSION
	005-879	28	879MM (34.61in) LENGTH OF SLOTWALL EXTRUSION
	005-879	2	879MM (34.61in) LENGTH OF SLOTWALL EXTRUSION -WITH 27.75MM BOTTOM CUT
	824-512	4	512MM (20.16in) SUPPORT LEG
	830-2350	2	2350MM (92.52in) MIDDLE UPRIGHT
	830-EC	2	7MM SEG PLASTIC END CAP FOR 830 EXTRUSION
	831-2350	1	2350MM (92.52in) LEFT UPRIGHT
	831-2350	1	2350MM (92.52in) RIGHT UPRIGHT
	831-EC	2	7MM SEG PLASTIC END CAP FOR 831 EXTRUSION
	835-883-01-01	6	883MM (34.76in) OF SINGLE SIDED SEG EXTRUSION -WITH CAM LOCKS BOTH ENDS
	MFY-36-17-BASE-PAN	3	36in WIDE X 17.25in DEEP - DROP-IN BASE PAN
	MFY-BOLT-375-16-2.5	4	3/8-16 x 2.5"L bolt
	MFY-BRKT3	6	WALL BRACKET

Kit Graphics BOM

ITEM	COMPONENTS	QTY	DESCRIPTION
	MFY-SS-03-G	1	(39.26 w X 96.61 h total size) 35.26 w X 92.61 h finish size, Dye-sub print on Eclipse Blockout Stretch, single sided, sewn with FCE-2 silicone beading around perimeter & pull tab in bottom right corner (WITH 1/4" NOTCH LEFT & RIGHT BOTTOM HORIZONTAL SIDE CORNERS)