

MODify Single Sided Kit 04

MODify™ is a one-of-a-kind Modular Merchandising System that is made up of interchangeable fixtures and accessories that can be easily assembled, disassembled, and rearranged to create a variety of different display configurations. The MODify system incorporates SEG push-fit fabric graphics that enable you to brand, promote and merchandise with ease.

MODify Single Sided Kit 04 is a versatile retail display solution that consists of three slatwall panels, each featuring push-fit graphic headers. With this kit, you can easily personalize and MODify it by incorporating various fixtures or furniture, allowing you to highlight your products in a way that best suits your needs.



MODify Single Sided Kits should be mounted to a wall or structure for safety and stability.

We are continually improving and modifying our product range and reserve the right to vary the specifications without prior notice. All dimensions and weights quoted are approximate and we accept no responsibility for variance. E&OE. See Graphic Templates for graphic bleed specifications

features and benefits:

Base Kit includes:

- Frame, slatwall, shelf and base colors in kit are all the same, your choice of all white, black, or silver
- Heavy-duty aluminum frame, steel base
- Steel, slotted uprights
- Three single sided 35"W x 96"H slatwall panels
- Three 35"W x 11"H SEG push-fit graphic headers
- Non-rolling base
- Display is easy to assemble and install
- Lifetime hardware warranty against manufacturer defects

Optional Accessories Include:

- Towel bars.
- Faceout bars
- Waterfalls
- U bars
- Slatwall hooks
- Shelves

dimensions:

Hardware

Assembled unit:

110"W x 96"H x 20.50"D
2794mm(w) x 2438.4mm(h) x 520.7mm(d)

Approximate Weight:
259 lbs / 117.48 kg

Shipping

Packing case(s):
1 Box

Shipping dimensions:
(96" L x 20" H x 24" D)
2438.4mm(l) x 508mm(h) x 609.6mm(d)

Approximate shipping weight:
332 lbs / 149.685 kg

additional information:

Graphics

Graphic material: Dye-sublimated fabric

See graphic templates for graphic sizes.

Refer to related graphic templates for more information Visit:

<https://www.theexhibitorshandbook.com/downloads/download-graphic-templates>
or click here

Powder coat color options:

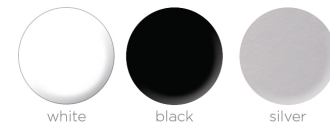

Wood laminate color options:

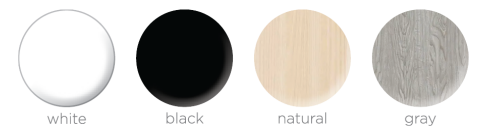

MODify Accessories

All Accessories available in white, black, or silver

Slotwall Accessories

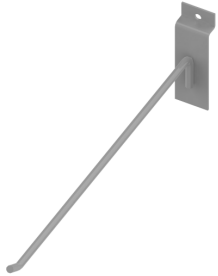

MFY-SLT-HK
4", 6", 8", 10" & 12"

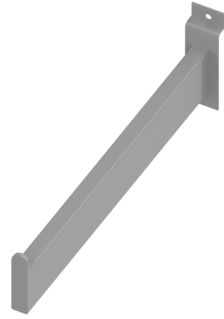

MFY-SLT-FC
6", 8", 10" & 12"

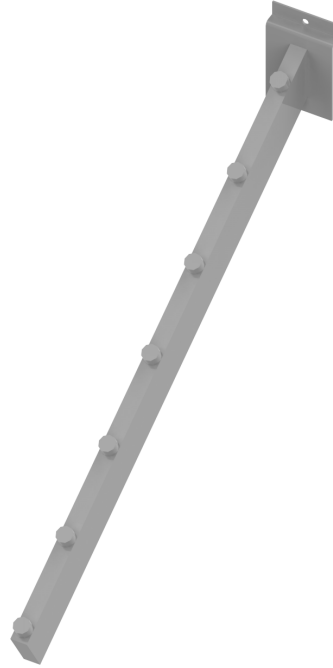

MFY-SLT-WTR-16-7

U-Bar Accessories

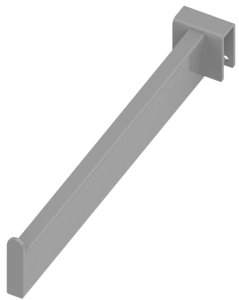

MFY-TWL-FC
6", 8" & 10"

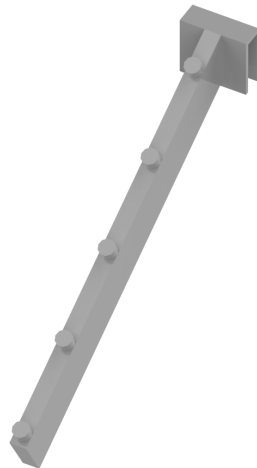

MFY-UBR-FC
6", 8" & 10"

Shelf and Hanger Bars

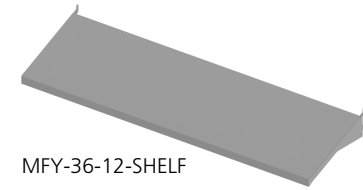

MFY-36-12-SHELF

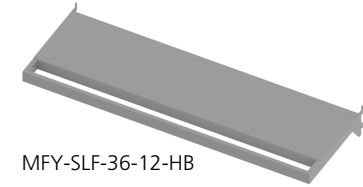

MFY-SLF-36-12-HB

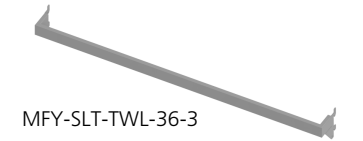

MFY-SLT-TWL-36-3



MFY-UBR-36-12

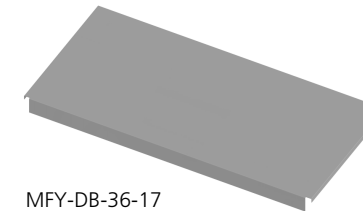

MFY-DB-36-17

Tools Required



MULTI HEX KEY
(INCLUDED)



PHILLIPS SCREW DRIVER
(NOT INCLUDED)



9/16" SOCKET WRENCH
(NOT INCLUDED)

How to Apply & Remove Graphics

Installation and removal of SEG graphics is easy!

Installation: Push the SEG bead into each corner of the frame (1-4) with your thumb, then push the SEG bead into the middle of the run (5-8) and work your way around the perimeter of the frame until all beading is pushed in properly; if necessary, go around the perimeter again to ensure beading is secure in the extrusion profile.

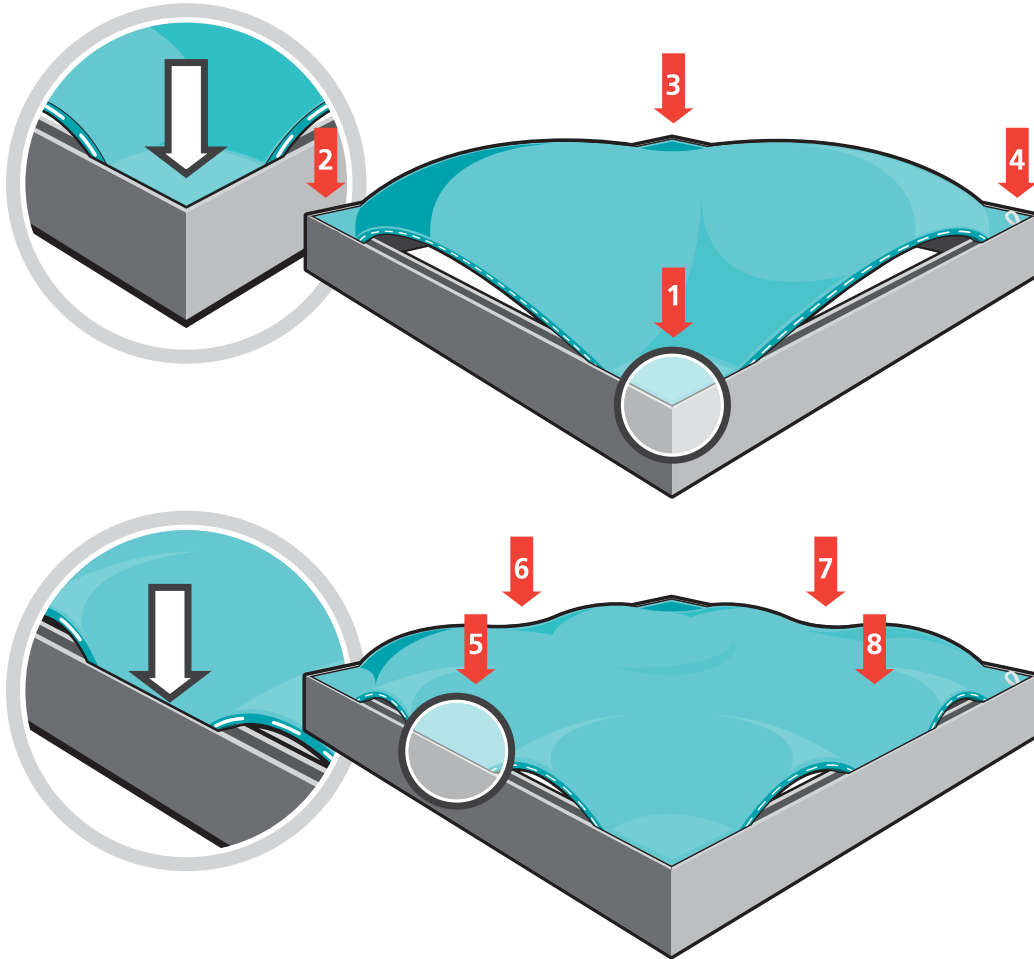

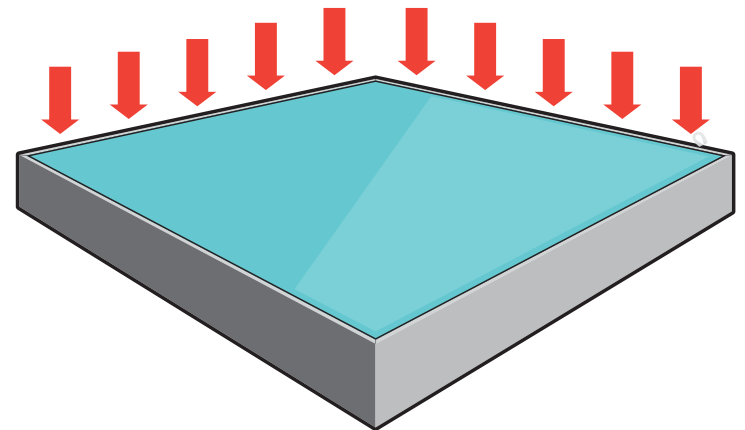

Note: Keep the set up area clean by using a drop cloth, washing hands before set-up or by wearing gloves.

Removal: Use the pull tab located on the graphic and gently pull the graphic from the frame, going around the perimeter.



Graphics Storage & Care

Graphics should be folded with the graphic facing inward and stored in a zip lock /sealable plastic bag. Spot clean by wiping with a damp white cloth. If washing is necessary, use a commercial size front-loading washing machine, gentle cycle with cool water. Line dry flat. Dry cleaning is NOT recommended to prevent shrinkage.

QTY	IMAGE	DESCRIPTION
6		1973MM (77.68in) OF SWC EXTRUSION
4		512MM (20.16in) SUPPORT LEG
4		3/8-16 x 2.5"L bolt
1		2350MM (92.52in) UPRIGHT RIGHT
2		2350MM (92.52in) OF 830 UPRIGHT MIDDLE
1		2350MM (92.52in) UPRIGHT LEFT

SETUP INSTRUCTIONS

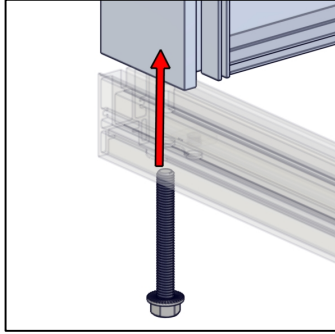
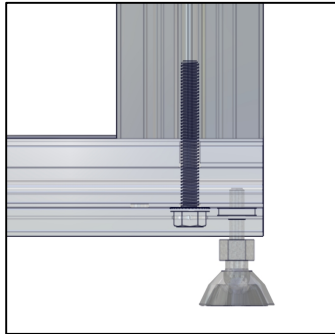

MFY-BOLT-375-16-2.5

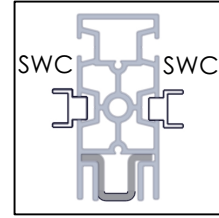
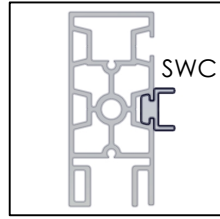

MIDDLE UPRIGHT

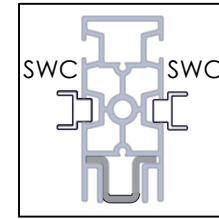

MIDDLE UPRIGHT

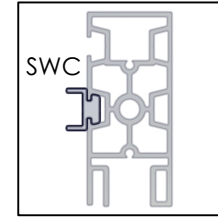

RIGHT UPRIGHT

LEFT UPRIGHT

SWC PRE-INSTALLED

SWC PRE-INSTALLED

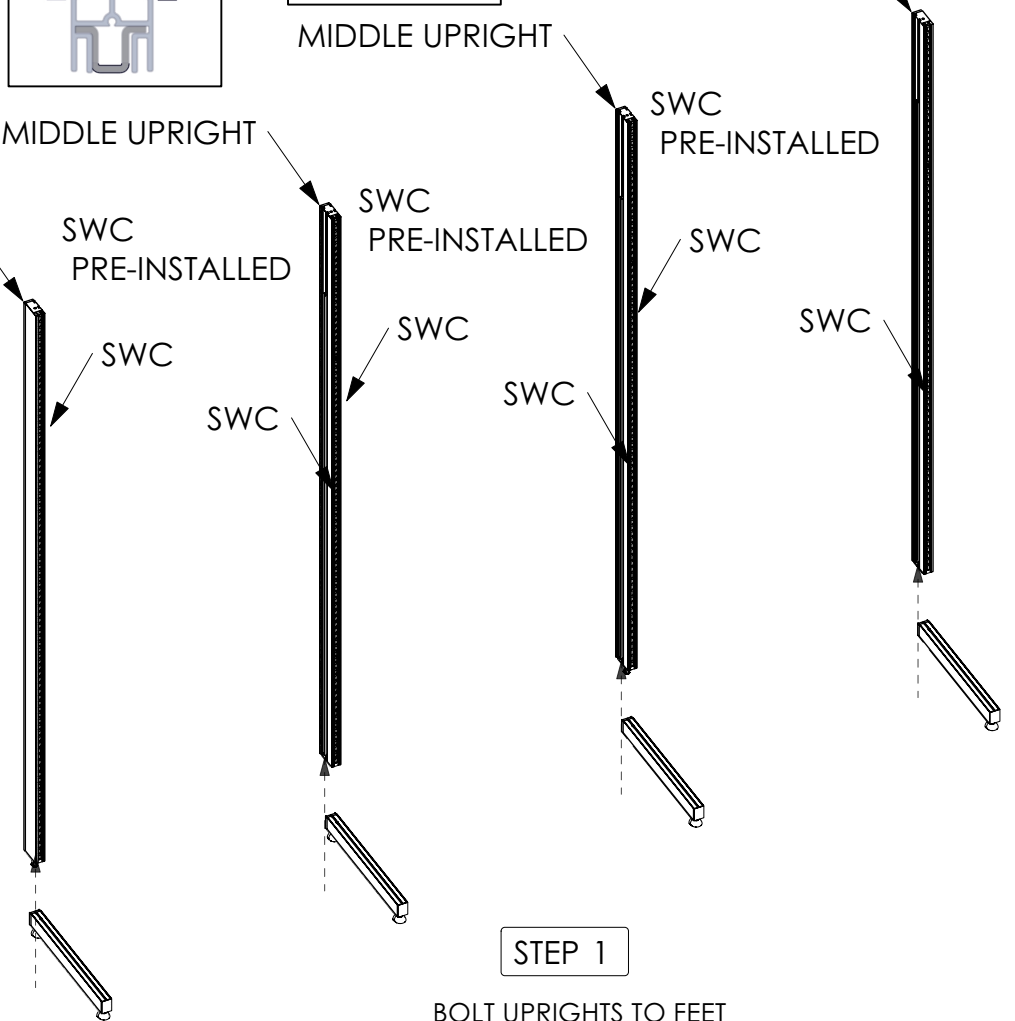
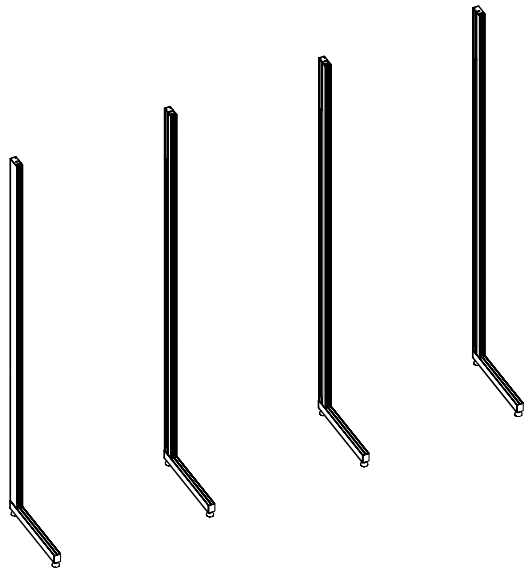

SWC PRE-INSTALLED

SWC



STEP 1

BOLT UPRIGHTS TO FEET

QTY	IMAGE	DESCRIPTION
3		883MM (34.7in) OF SWC EXTRUSION
3		883MM (34.7in) OF 835 DOUBLE SIDED SEG EXTRUSION -WITH CAM LOCKS BOTH ENDS
6		WALL BRACKET

SETUP INSTRUCTIONS

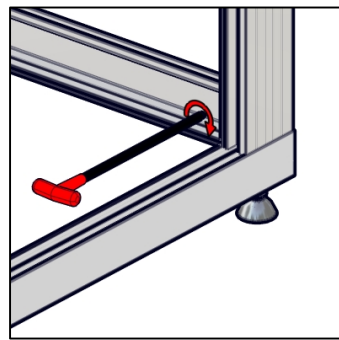

CROSS BRACE SITS ON SUPPORT LEG

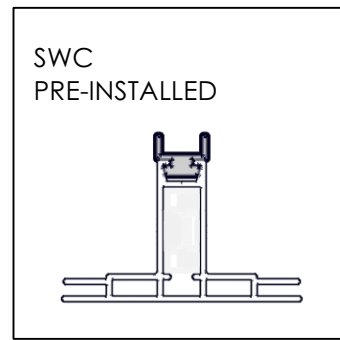

SWC PRE-INSTALLED
SLOT WALL TOP CHANNEL

STEP 5

* LOCK TOP CROSS BRACE (TEMPORARY INSTALLED) TO ALIGN WALL MOUNT CLIPS

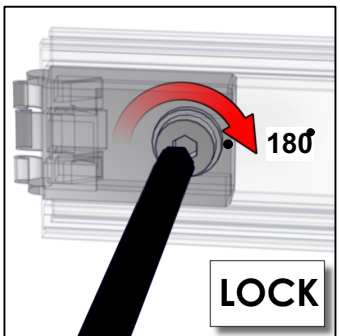

IMPORTANT!
MAKE A HALF TURN TO LOCK EXTRUSIONS

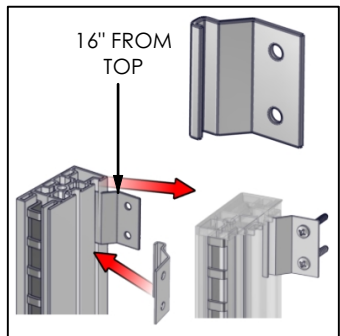

WALL MOUNT CLIPS

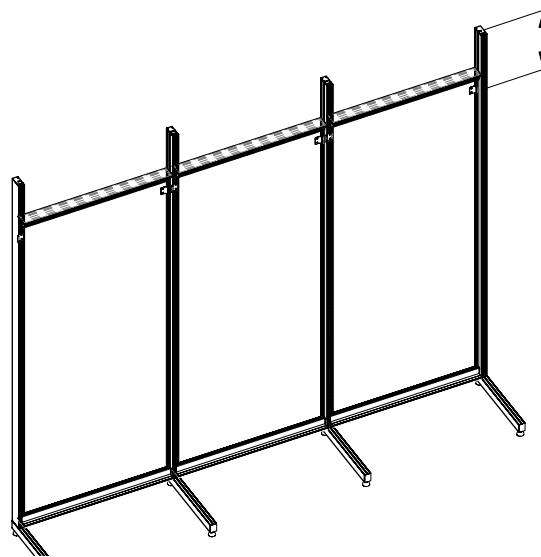

16" FROM TOP
IMPORT
*FASTEN CLIPS TO WALL

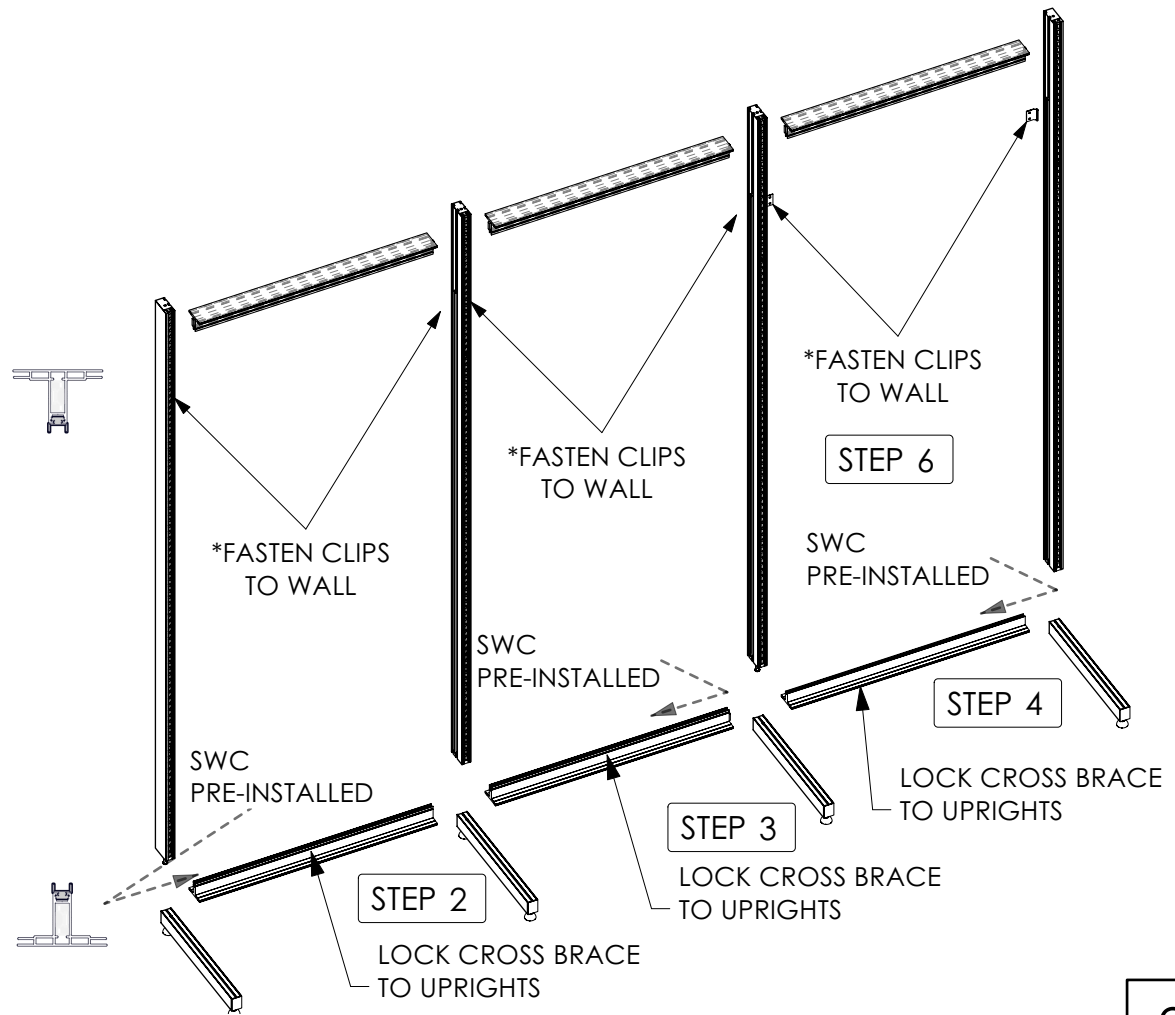

STEP 6

*FASTEN CLIPS TO WALL

*FASTEN CLIPS TO WALL

*FASTEN CLIPS TO WALL

SWC PRE-INSTALLED

SWC PRE-INSTALLED

SWC PRE-INSTALLED

STEP 3

LOCK CROSS BRACE TO UPRIGHTS



STEP 4

LOCK CROSS BRACE TO UPRIGHTS

STEP 2

LOCK CROSS BRACE TO UPRIGHTS

Disclaimer: Unit must be permanently secured and fastened to wall or other structure for stability.

QTY	IMAGE	DESCRIPTION
1		883MM (34.7in) OF SWC EXTRUSION
1		883MM (34.7in) OF 835 DOUBLE SIDED SEG EXTRUSION -WITH CAM LOCKS BOTH ENDS
13		879MM (34.61in) LENGTH OF SLOTWALL EXTRUSION

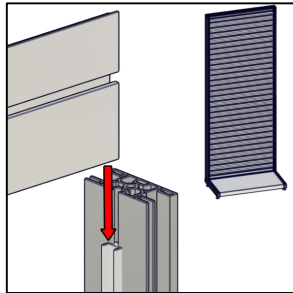
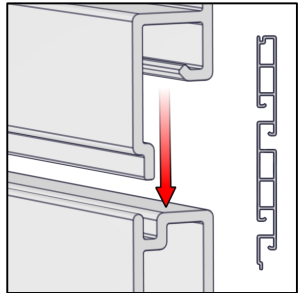

SLOTWALL 005

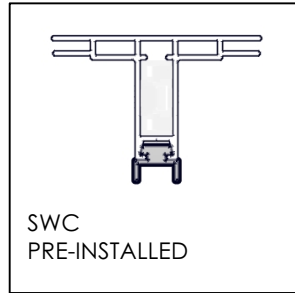

SWC
PRE-INSTALLED

SLOT WALL TOP
CHANNEL

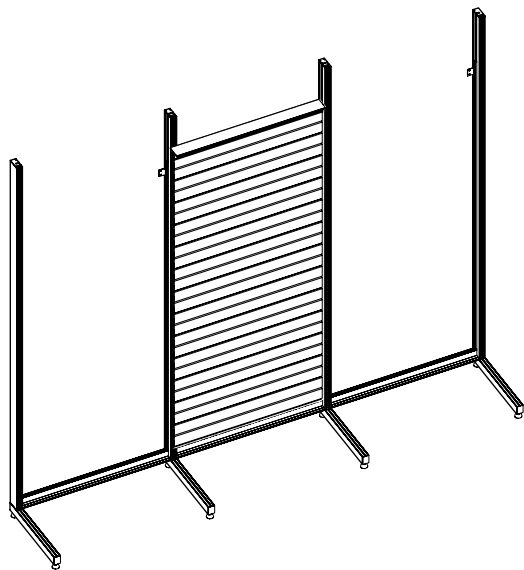

SETUP INSTRUCTIONS

STEP 7

* REMOVE TOP CROSS BRACE
(TEMPORARY INSTALLED)

STEP 8

SLOTWALL
EXTRUSION
STACK 005-879



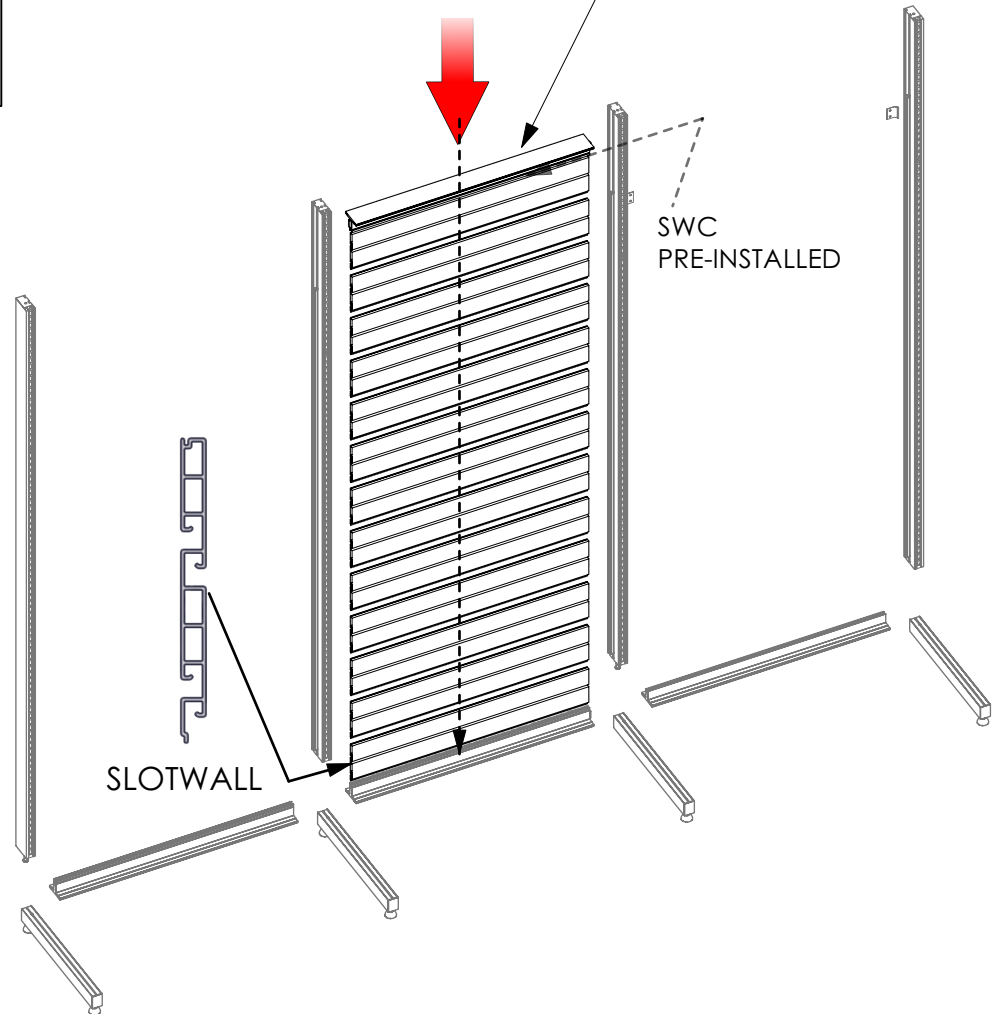

STEP 9

LOCK CROSS BRACE
TO UPRIGHTS AND
PLACE END CAPS



SETUP INSTRUCTIONS

2		883MM (34.76in) OF SWC EXTRUSION
2		883MM (34.76in) OF 835 DOUBLE SIDED SEG EXTRUSION -WITH CAM LOCKS BOTH ENDS
26		879MM (34.61in) LENGTH OF SLOTWALL EXTRUSION

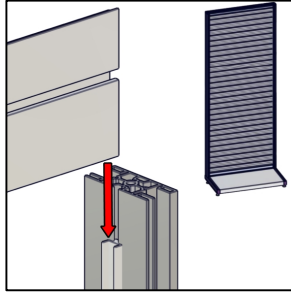
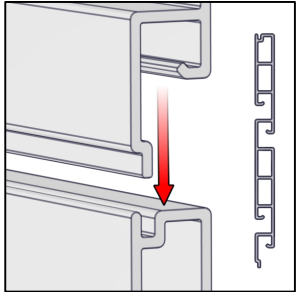
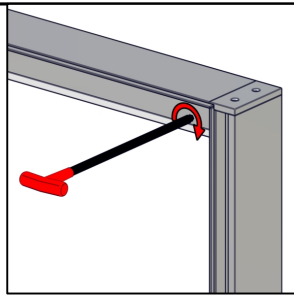

SLOTWALL 005

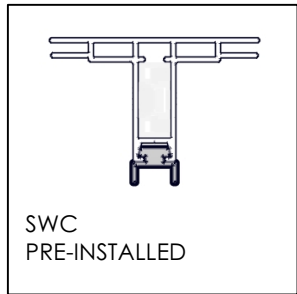

SWC PRE-INSTALLED

SLOT WALL TOP CHANNEL

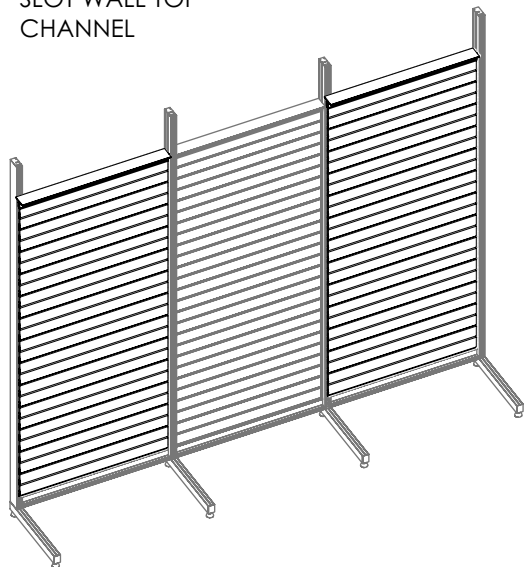

STEP 10

SLOTWALL EXTRUSION STACK 005-879



SWC PRE-INSTALLED

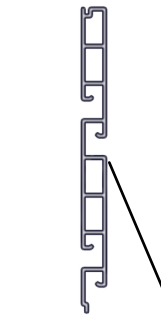

SLOTWALL

STEP 12

LOCK CROSS BRACE TO UPRIGHTS

STEP 11

SLOTWALL EXTRUSION STACK 005-879



SWC PRE-INSTALLED

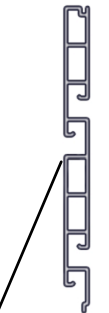

SLOTWALL

SETUP INSTRUCTIONS

QTY	IMAGE	DESCRIPTION
3		36in WIDE X 17.25in DEEP - DROP-IN BASE PAN
3		883MM (34.7in) OF 835 DOUBLE SIDED SEG EXTRUSION -WITH CAM LOCKS BOTH ENDS
3		(39.26 w X 15.07 h total size) 35.26 w X 11.07 h finish size, Dye-sub print on Eclipse Blockout Stretch, single sided, sewn with FCE-2 silicone beading around perimeter & pull tab in bottom right corner (WITH 1/4" NOTCH LEFT & RIGHT BOTTOM HORIZONTAL SIDE CORNERS)
2		7MM SEG PLASTIC END CAP FOR 831 EXTRUSION
2		7MM SEG PLASTIC END CAP FOR 830 EXTRUSION

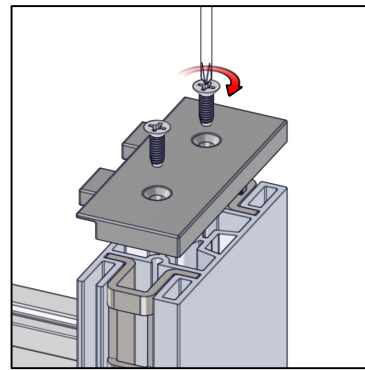

LOOSEN END CAP TO ATTACH TOP CROSS BRACE

STEP 13

LOCK TOP CROSS BRACE TO UPRIGHTS AND PLACE END CAPS

STEP 14

INSTALL GRAPHICS

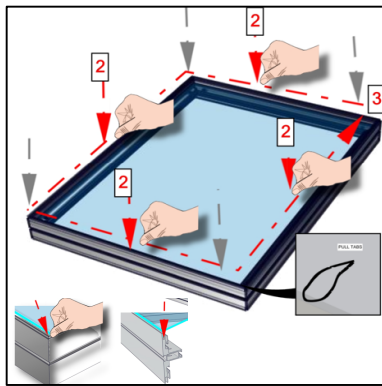

THEN PRESS ALONG THE PERIMETER EDGE

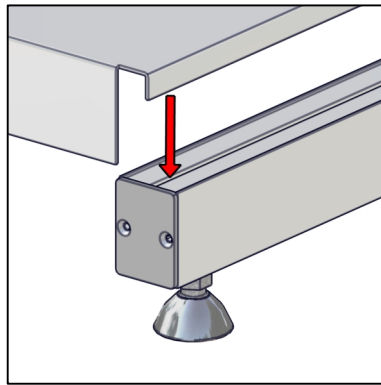

MFY-36-17-BASE-PAN

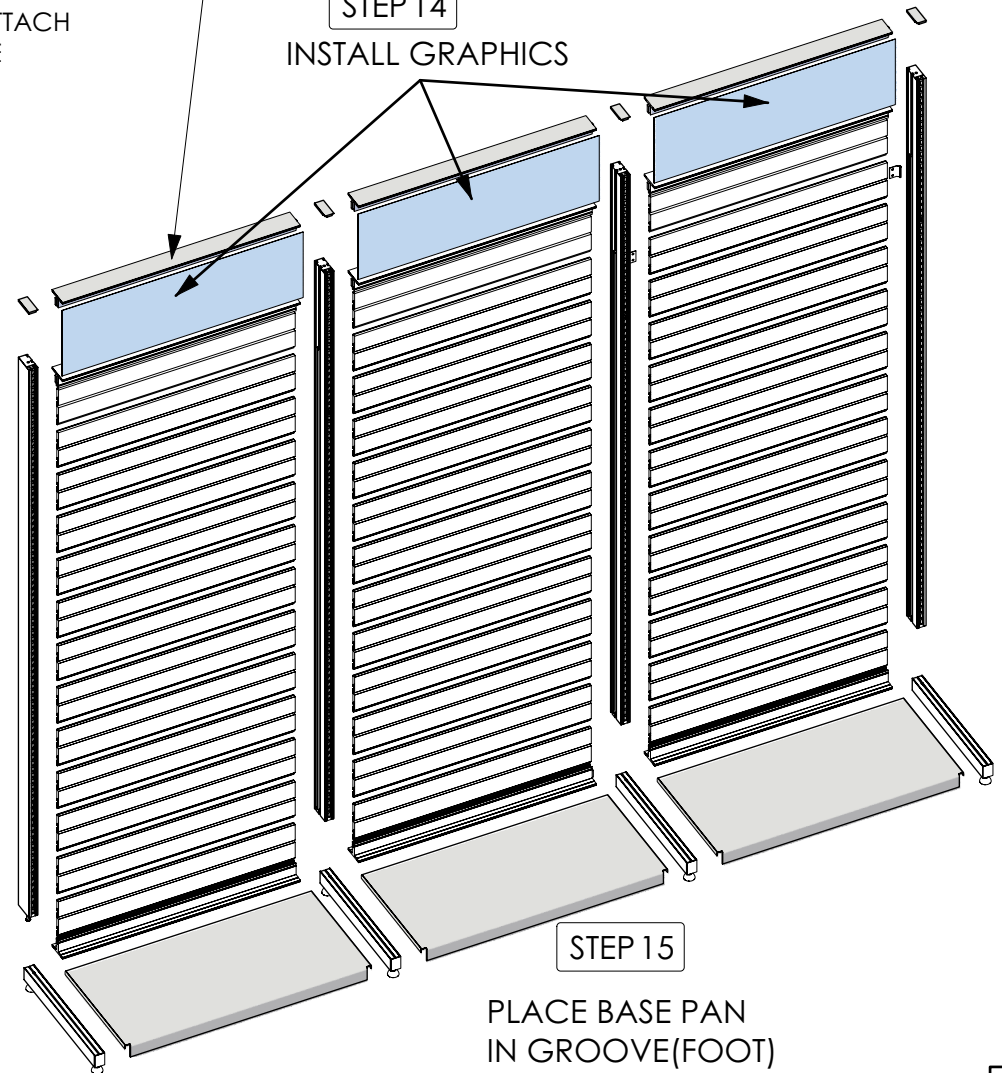





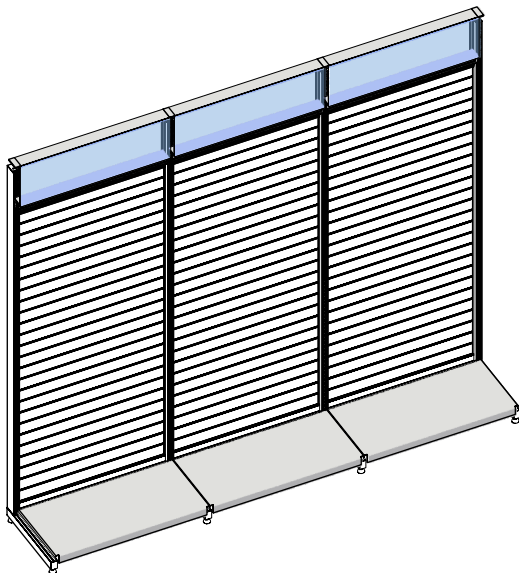







STEP 15



PLACE BASE PAN IN GROOVE(FOOT)



Kit Hardware BOM

ITEM	COMPONENTS	QTY	DESCRIPTION
	004-883	6	883MM (34.76in) OF SWC EXTRUSION
	004-1973	6	1973MM (77.68in) OF SWC EXTRUSION
	005-879	39	879MM (34.61in) LENGTH OF SLOTWALL EXTRUSION
	824-512	4	512MM (20.16IN) SUPPORT LEG
	830-2350	2	2350MM (92.52in) OF 830 UPRIGHT MIDDLE
	830-EC	2	7MM SEG PLASTIC END CAP FOR 830 EXTRUSION
	831-2350	1	2350MM (92.52in) UPRIGHT LEFT
	831-2350	1	2350MM (92.52in) UPRIGHT RIGHT
	831-EC	2	7MM SEG PLASTIC END CAP FOR 831 EXTRUSION
	835-883-01-01	9	883MM (34.76in) OF 835 DOUBLE SIDED SEG EXTRUSION -WITH CAM LOCKS BOTH ENDS
	MFY-BOLT-375-16-2.5	4	3/8-16 x 2.5"L bolt
	MFY-BRKT3	6	WALL BRACKET
	MFY-DB-36-17	3	36in WIDE X 17.25in DEEP - DROP-IN BASE PAN

Kit Graphics BOM

ITEM	COMPONENTS	QTY	DESCRIPTION
	MFY-SS-04-A-G	1	(39.26 w X 15.07 h total size) 35.26 w X 11.07 h finish size, Dye-sub print on Eclipse Blockout Stretch, single sided, sewn with FCE-2 silicone beading around perimeter & pull tab in bottom right corner (WITH 1/4" NOTCH LEFT & RIGHT BOTTOM HORIZONTAL SIDE CORNERS)
	MFY-SS-04-B-G	1	(39.26 w X 15.07 h total size) 35.26 w X 11.07 h finish size, Dye-sub print on Eclipse Blockout Stretch, single sided, sewn with FCE-2 silicone beading around perimeter & pull tab in bottom right corner (WITH 1/4" NOTCH LEFT & RIGHT BOTTOM HORIZONTAL SIDE CORNERS)
	MFY-SS-04-C-G	1	(39.26 w X 15.07 h total size) 35.26 w X 11.07 h finish size, Dye-sub print on Eclipse Blockout Stretch, single sided, sewn with FCE-2 silicone beading around perimeter & pull tab in bottom right corner (WITH 1/4" NOTCH LEFT & RIGHT BOTTOM HORIZONTAL SIDE CORNERS)