

# Formulate 10' Four Sided Tower

## COL-02-BL

Mix and match the Formulate® line of towers to add architecture and drama to any event or interior space. Rectangular-shaped towers come in 12ft, 10ft and 8ft heights and 3ft square at the top and bottom. They combine the latest developments in fabric printed technology with aluminum tube frames to add dimension, decor and sculpture to any event, stage set, tradeshow booth or interior space. Formulate towers accommodate internal LED lighting to create a glowing effect.

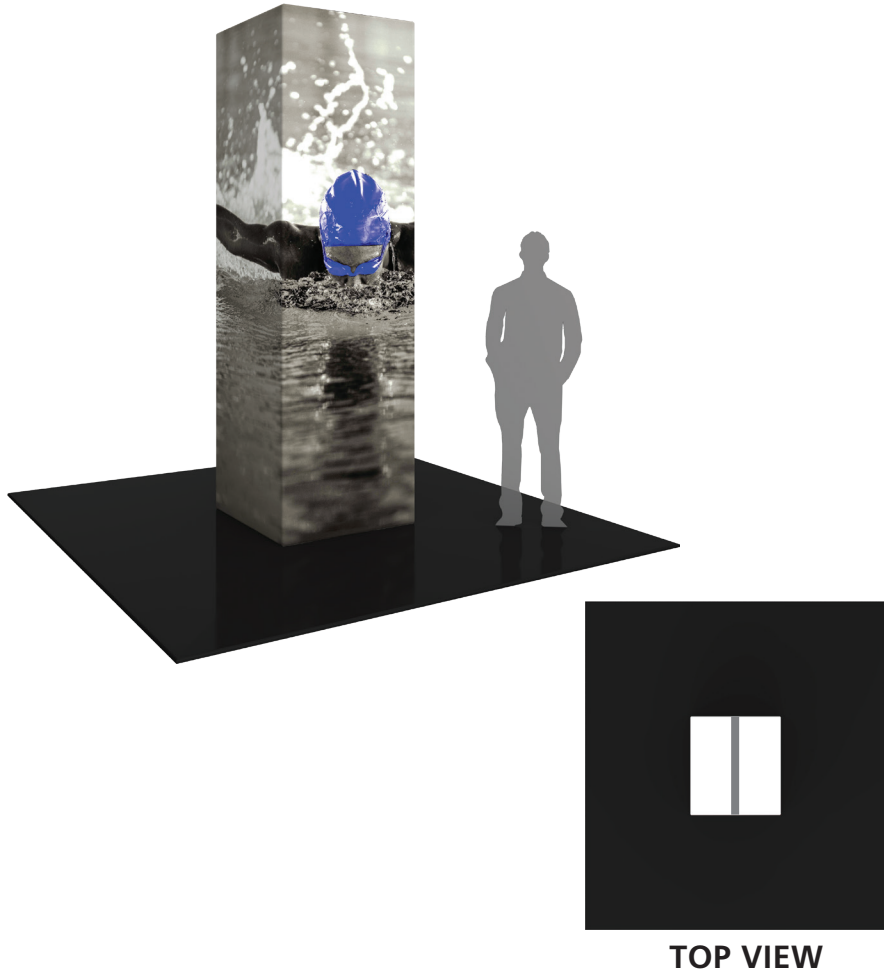

## features and benefits:

- State-of-the-art 30mm aluminum tube frame with snap button assembly
- Easy to store and ship
- Quick to set up
- Kit includes: one frame, one dye-sublimated zipper pillowcase graphic, internal lighting components, and one wheeled storage case
- Lifetime hardware warranty against manufacturer defects

## dimensions:

### Hardware

### Graphic

Assembled unit:  
36" w x 120" h x 36" d  
915mm(w) x 3048mm(h) x 915mm(d)

Refer to related graphic template for more information.

Approximate weight (includes graphic):  
29 lbs / 13 kg

Visit:  
<https://www.theexhibitorshandbook.com/download-graphic-templates>

### Shipping

## additional information:

Packing case(s):  
1 OCL

Graphic material:  
Dye-sublimation zipper pillowcase fabric

Shipping dimensions:  
OCL:  
56" l x 19" h x 19" d  
1422mm(l) x 483mm(h) x 483mm(d)

\*This unit requires 6 light bulbs

Approximate total shipping weight:  
49 lbs / 22 kg

When included in a larger kit, a different packaging solution will be listed to accommodate all contents of the kit. Individual packaging no longer provided.

We are continually improving and modifying our product range and reserve the right to vary the specifications without prior notice. All dimensions and weights quoted are approximate and we accept no responsibility for variance. E&OE. See Graphic Templates for graphic bleed specifications.

# Included In Your Kit

Tools, Components, & Connectors

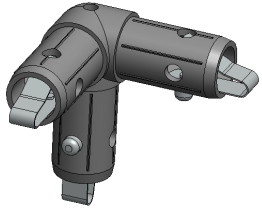

TC-30-3W x8

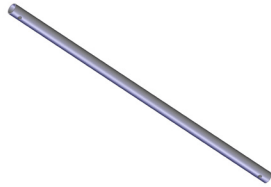

COL-02-T1 x6



COL-02-T2 x8



COL-02-T3 x4

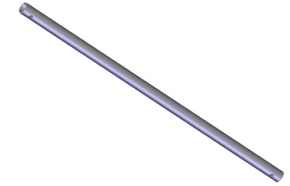

COL-02-T4 x1

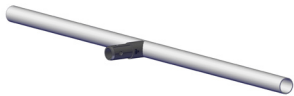

COL-02-T5 x2

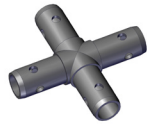

TC-30-X x1



LED-LT-PWR-CORD x2

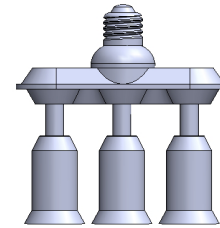

LED-LT-FXT-3WAY x2

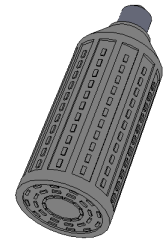

LED-CORN-24W x6



COL-02-T6 x4

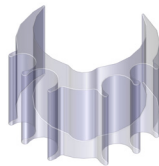

WC-30T x3

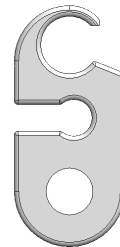

WIRE CONNECTION CLIP x2

Graphics



COL-02-BL-G x1

# Exploded View

COL-02-BL

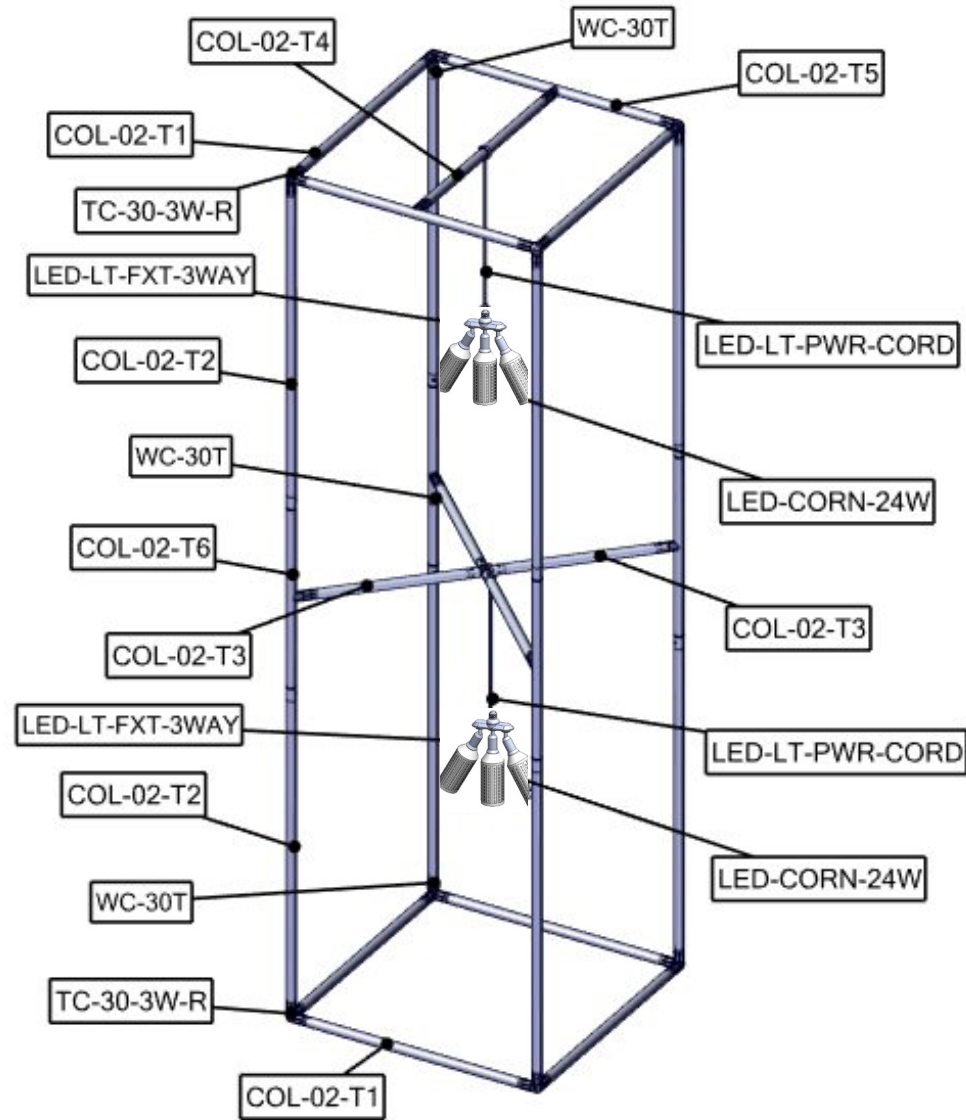

# Labeling Diagram

COL-02-BL

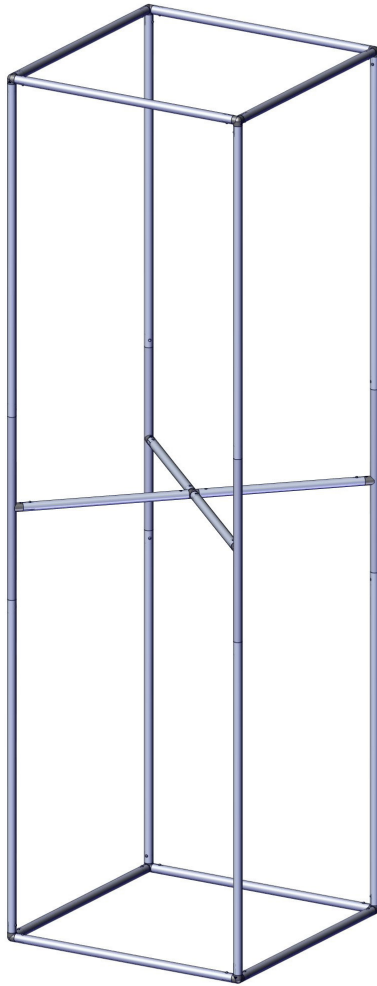

Section 1:

SECTION 1

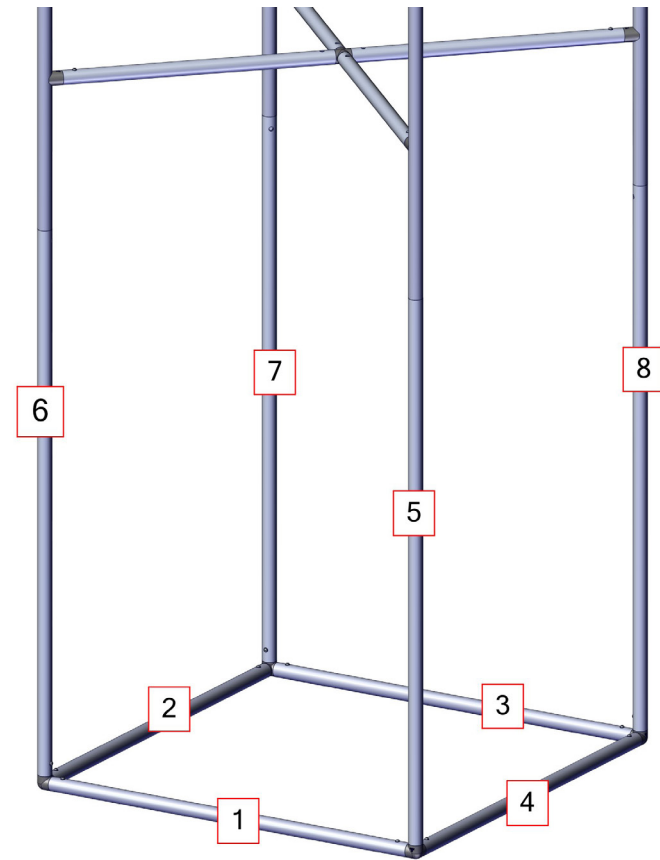

# Labeling Diagram

COL-02-BL

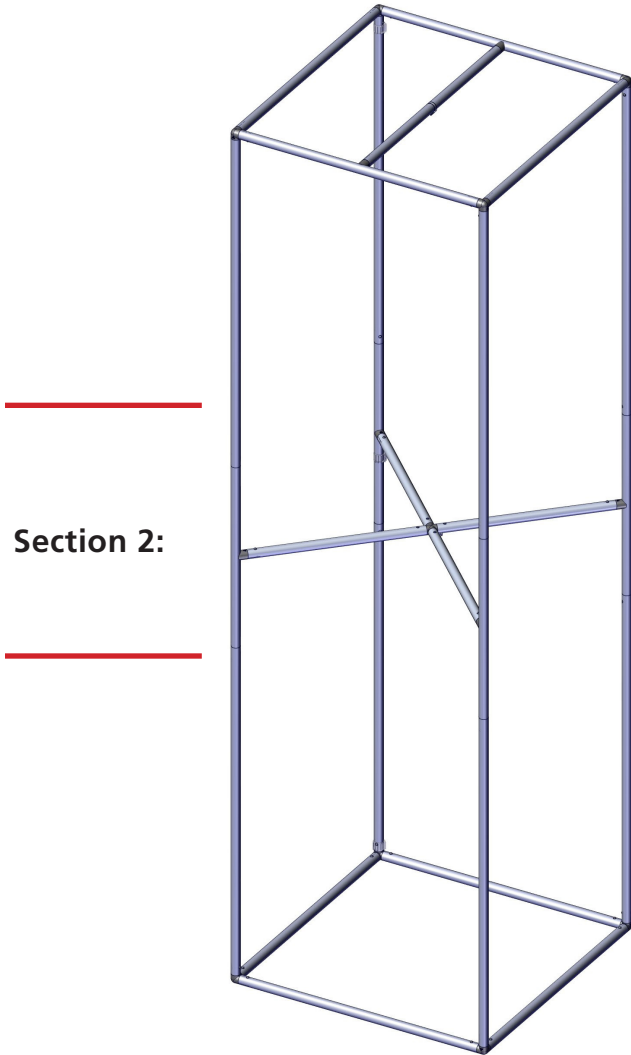

Section 2:

SECTION 2

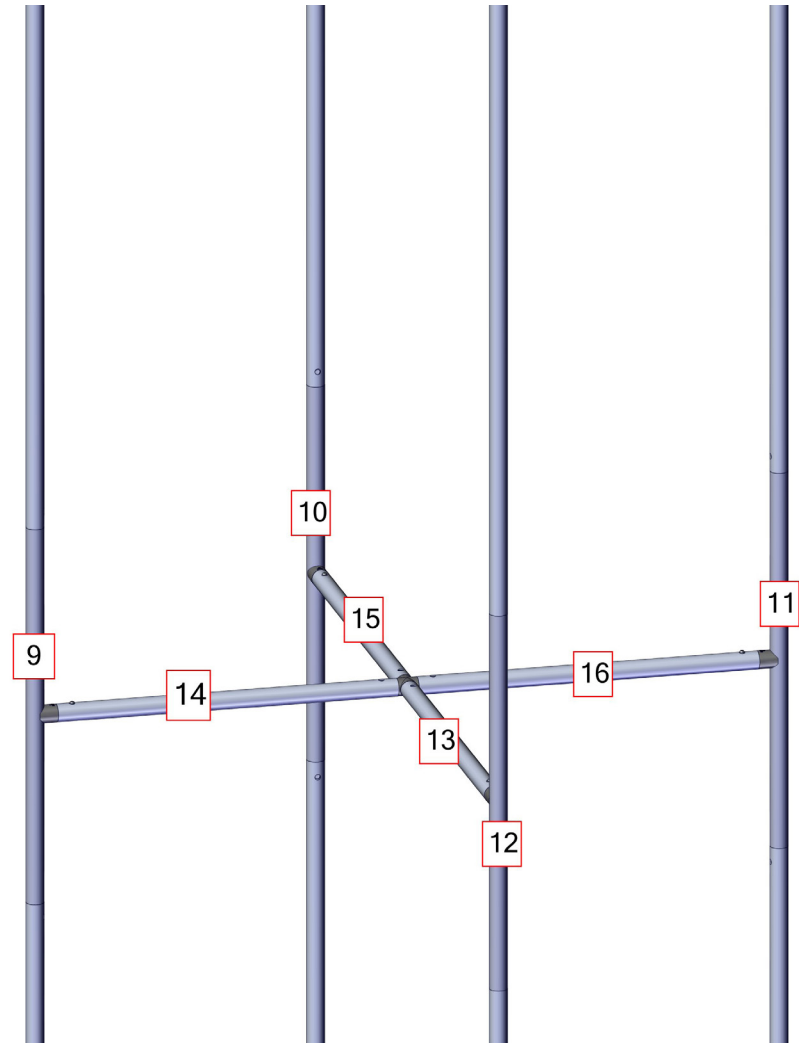

# Labeling Diagram

COL-02-BL

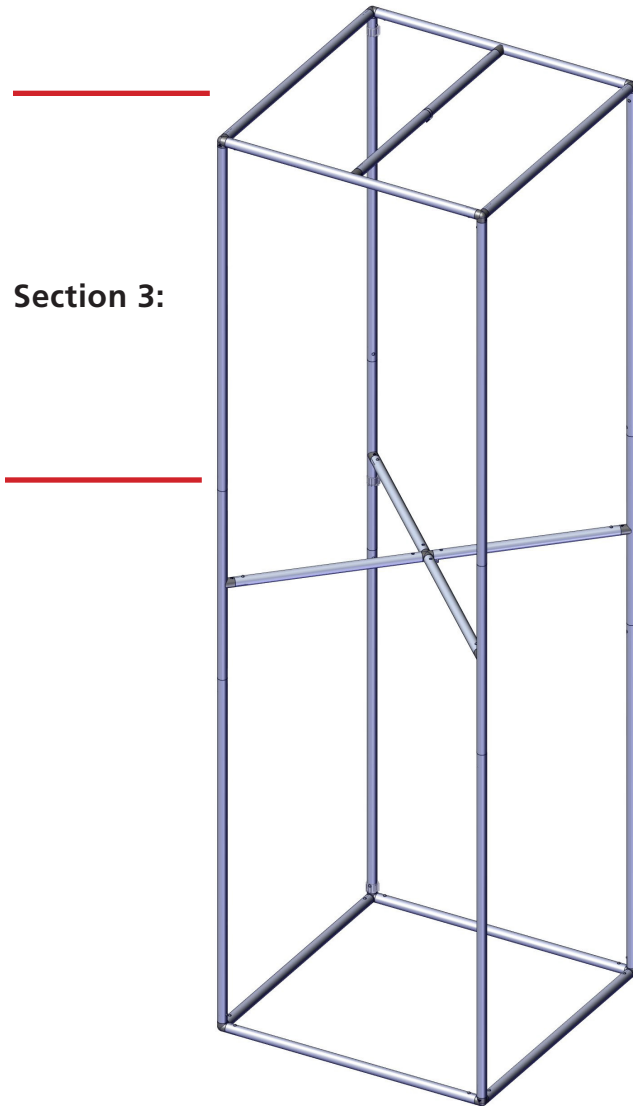

Section 3:

SECTION 3

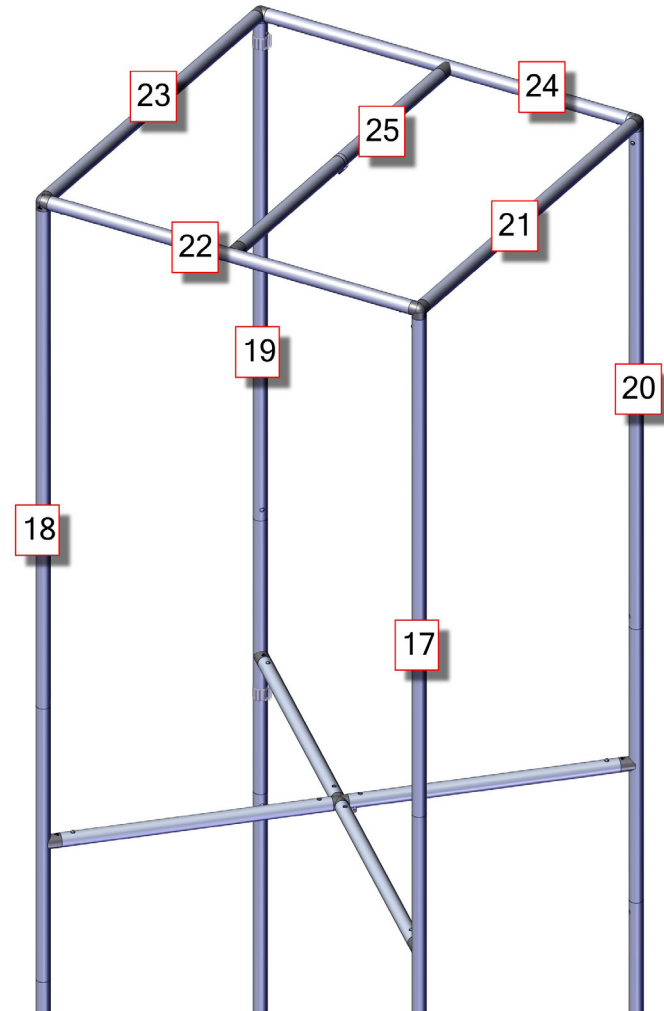

# Lighting Diagram

COL-02-BL

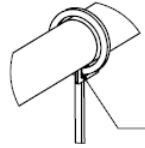

WIRE CONNECTION CLIP  
**TYP. X2**

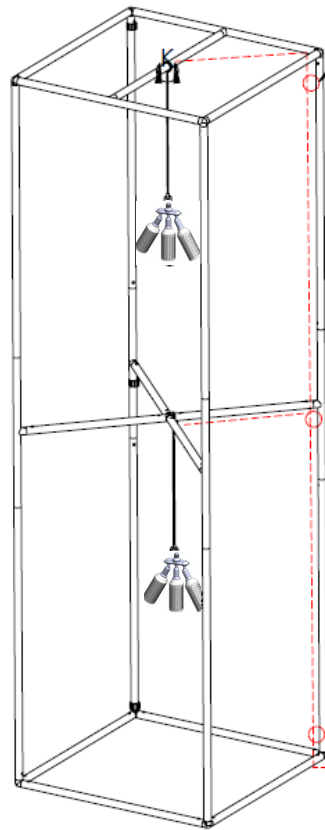

WIRE CLIP LOCATION  
TYP. X3



**WC-30T**

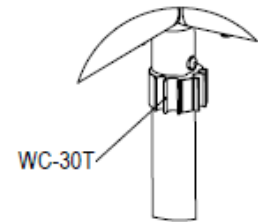

v110

**LED-LT-PWR-CORD x2**

# Kit Assembly

## Step by Step

### Step 1.

Gather the components to build Section 1 of the tower frame. Use the Exploded View and the Labeling Diagram for part labels.

Reference Connection Methods 2 for more details.

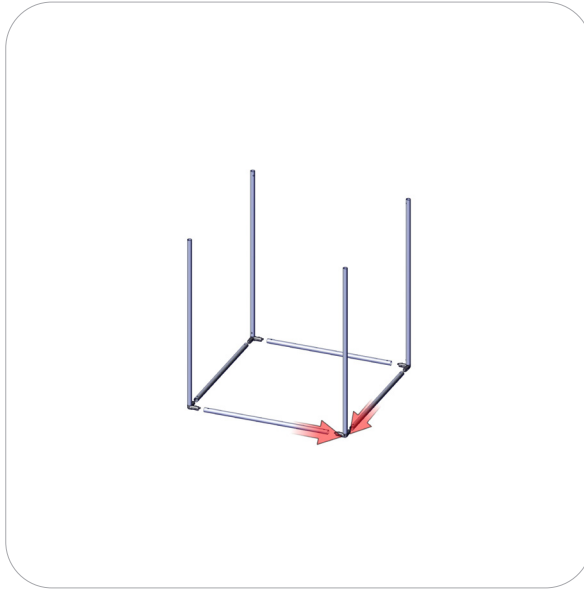

### Step 2.

Gather the components to build Section 2 of the tower frame. Use the Exploded View and the Labeling Diagram for part labels.

Reference Connection Method 3 and 4 for more details.

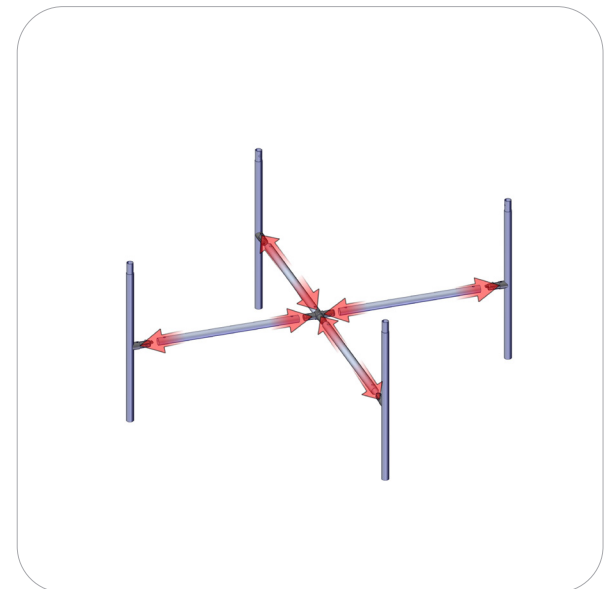
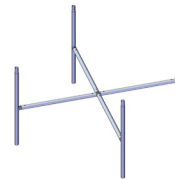

### Step 3.

Gather the components to build Section 3 of the tower frame. Use the Exploded View and the Labeling Diagram for part labels.

Reference Connection Methods 2 and 3 for more details.

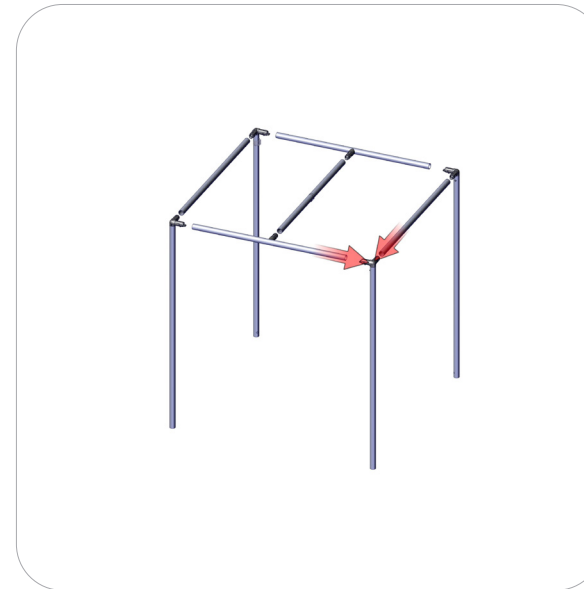

### Step 4.

Lay the three sections flat on floor. Combine them to complete the tower frame assembly. Use the Exploded View and the Labeling Diagram for part labels.

Reference Connection Method 1 for more details.

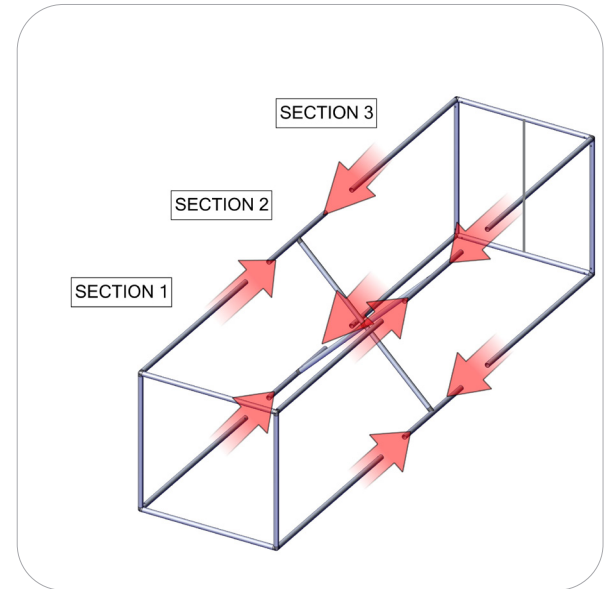



# Kit Assembly

## Step by Step

### Step 5.

Gather the components to connect lighting to the frame.

Connect the lighting components to the frame. Use the Exploded View and Lighting Diagram for part labels. These components simply hang from tube T4 at the top of the frame and the power cable runs down and out of the bottom opening.

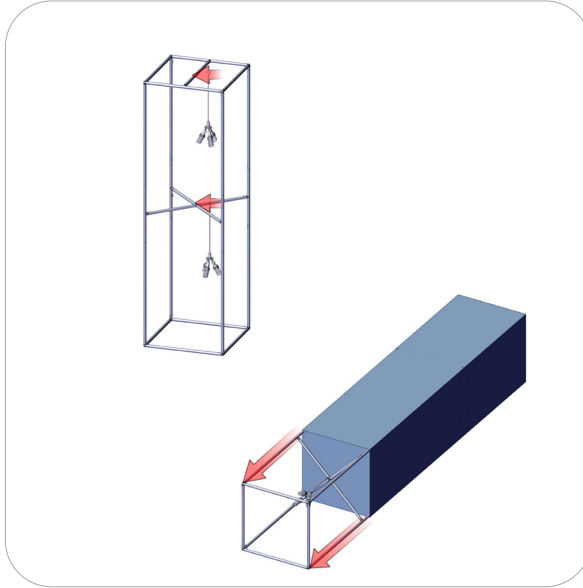

### Step 6.

Close the zippers and carefully stand the tower upright.

### Setup Complete

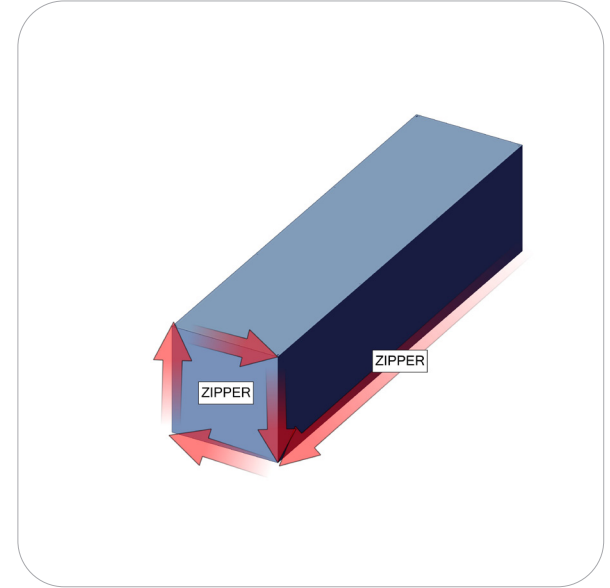

# Connection Methods

## Connection Method 1: SNAP BUTTONS

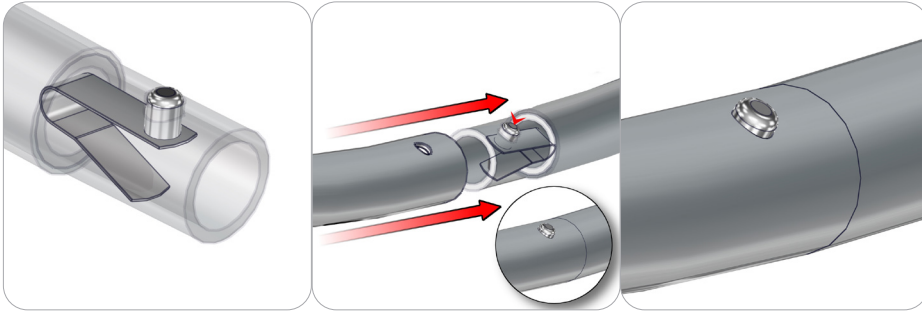

Snap button connections are simple and easy to use. First, locate the snap button on the connector or swage tube. Second, locate the hole on the corresponding tube. Press the snap button with your thumb and slide the tube and connector together so that the snap button snaps fully into the hole. To disassemble, press the snap button and carefully pull them apart.

## Connection Method 2: TC-30-3W-R

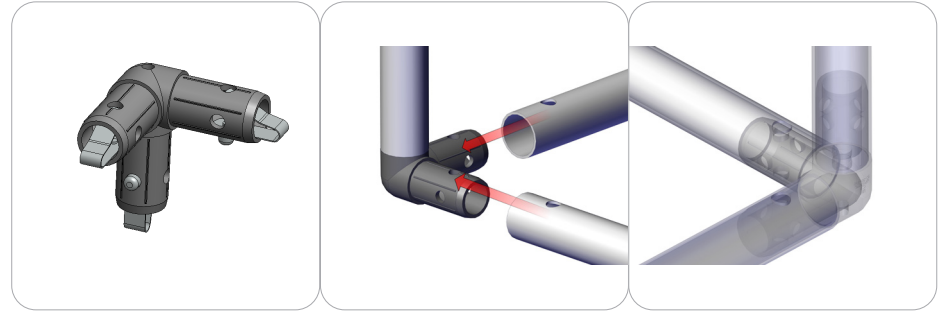

Snap button connections are simple and easy to use. First, locate the snap button on the connector or swage tube. Second, locate the hole on the corresponding tube. Press the snap button with your thumb and slide the tube and connector together so that the snap button snaps fully into the hole. To disassemble, press the snap button and carefully pull them apart.

## Connection Method 3: COL-02-T3/COL-02-T5/COL-02-T6

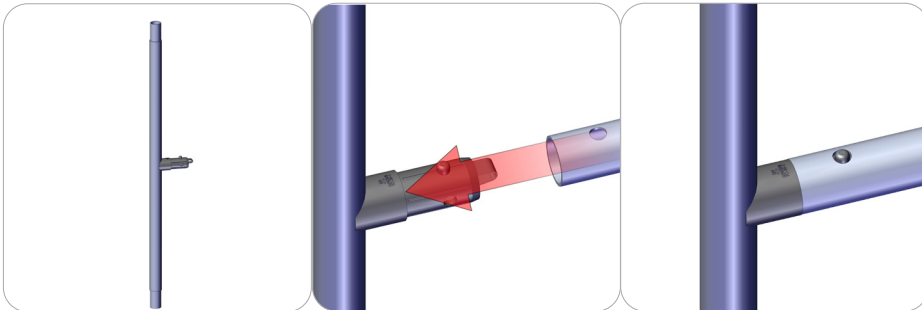

Snap button connections are simple and easy to use. First, locate the snap button on the connector or swage tube. Second, locate the hole on the corresponding tube. Press the snap button with your thumb and slide the tube and connector together so that the snap button snaps fully into the hole. To disassemble, press the snap button and carefully pull them apart.

## Connection Method 4: TC-30-X

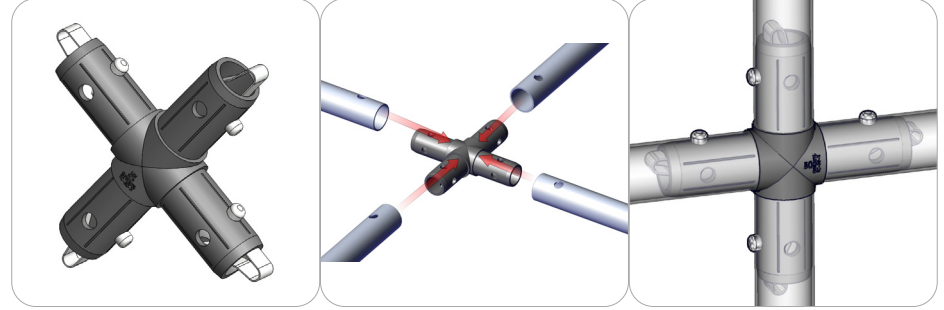

First, connect spreader tubes (COL-T3) to TC-30-X. Second, once the X frame is assembled, connect side tubes (COL-T6).