

# Formulate Master 5ft Straight Backlit Display

## FMLT-BL-WS5-01

The Formulate® 5ft Straight Backlit display is a captivating and eye-catching exhibit that combines an aluminum tube frame with LED light curtains and a zipper pillowcase printed fabric graphic. The LED light curtain helps draw attention to the display and offers even and bright white light balance throughout. An expandable, sturdy display case is included to protect the frame and LED light curtains in transit to events and tradeshow.

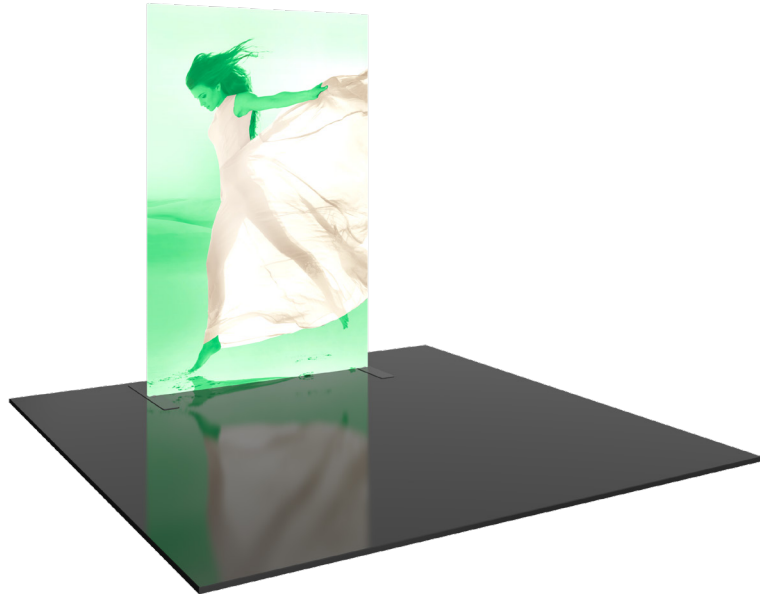

## features and benefits:

- State-of-the-art 50mm aluminum tube frame with push-button connection and spigot assembly
- LED light curtains easily attach to the frame at the top and bottom
- Pillowcase fabric graphic is printed on backlit textile and includes an opaque backer
- Kit includes: one frame, one dye-sublimated zipper pillowcase graphic, two light curtains, one transformer, and one wheeled OCE-2 molded storage case
- Easy to store and ship
- Lifetime hardware warranty against manufacturer defects

## dimensions:

### Hardware

### Graphic

Assembled unit:  
61.94" w x 92" h x 26.57" d  
1574mm(w) x 2337mm(h) x 675mm(d)

Refer to related graphic template for more information.

Approximate weight:  
45 lbs / 21 kg

One year warranty.

Visit:  
<https://www.theexhibitorshandbook.com/download-graphic-templates>

### Shipping

## additional information:

Packing case(s):  
1 OCE-2

Shipping dimensions:  
OCE-2: Expandable case length (l) may vary  
40" - 66" l x 18" h x 18" d  
1016-1677mm(l) x 458mm(h) x 458mm(d)

Graphic material:  
Dye-sublimation zipper pillowcase fabric -  
Backlit textile with opaque backer

When included in a larger kit, a different packaging solution will be listed to accommodate all contents of the kit. Individual packaging no longer provided.

Approximate total shipping weight:  
70 lbs / 32 kg



This product may include the following materials for recycle:  
aluminum, select wood, fabric, cardboard, paper, steel, and plastics.

We are continually improving and modifying our product range and reserve the right to vary the specifications without prior notice. All dimensions and weights quoted are approximate and we accept no responsibility for variance. E&OE. See Graphic Templates for graphic bleed specifications.

# Included In Your Kit

Tools, Components, & Connectors

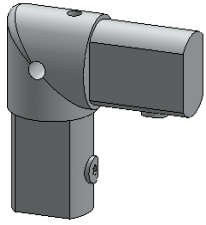

ES50-2W x2

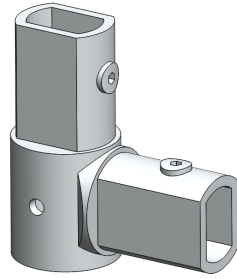

ES50-I-ES50-C-ASY x2

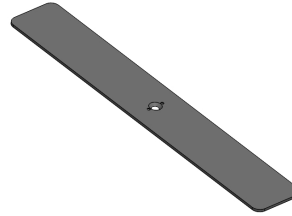

LN114-S2-650 x2

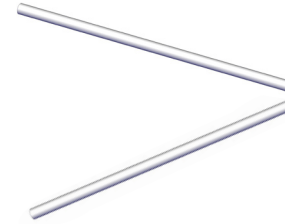

FMLT-BL-WS5-01-SIDE x2



FMLT-BL-WS5-01-T2 x2



FMLT-BL-CURTAIN LIGHT x2



FMLT-BL-CURTAIN-TRANS-2 x1

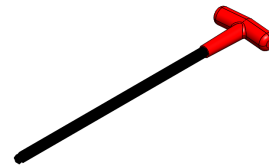

5MM ALLEN-T x1



MULTI HEX KEY x1



M10 SCREW vx2

Graphics



FMLT-BL-WS5-01-G x1

# Exploded Diagram

FMLT-BL-WS5-01

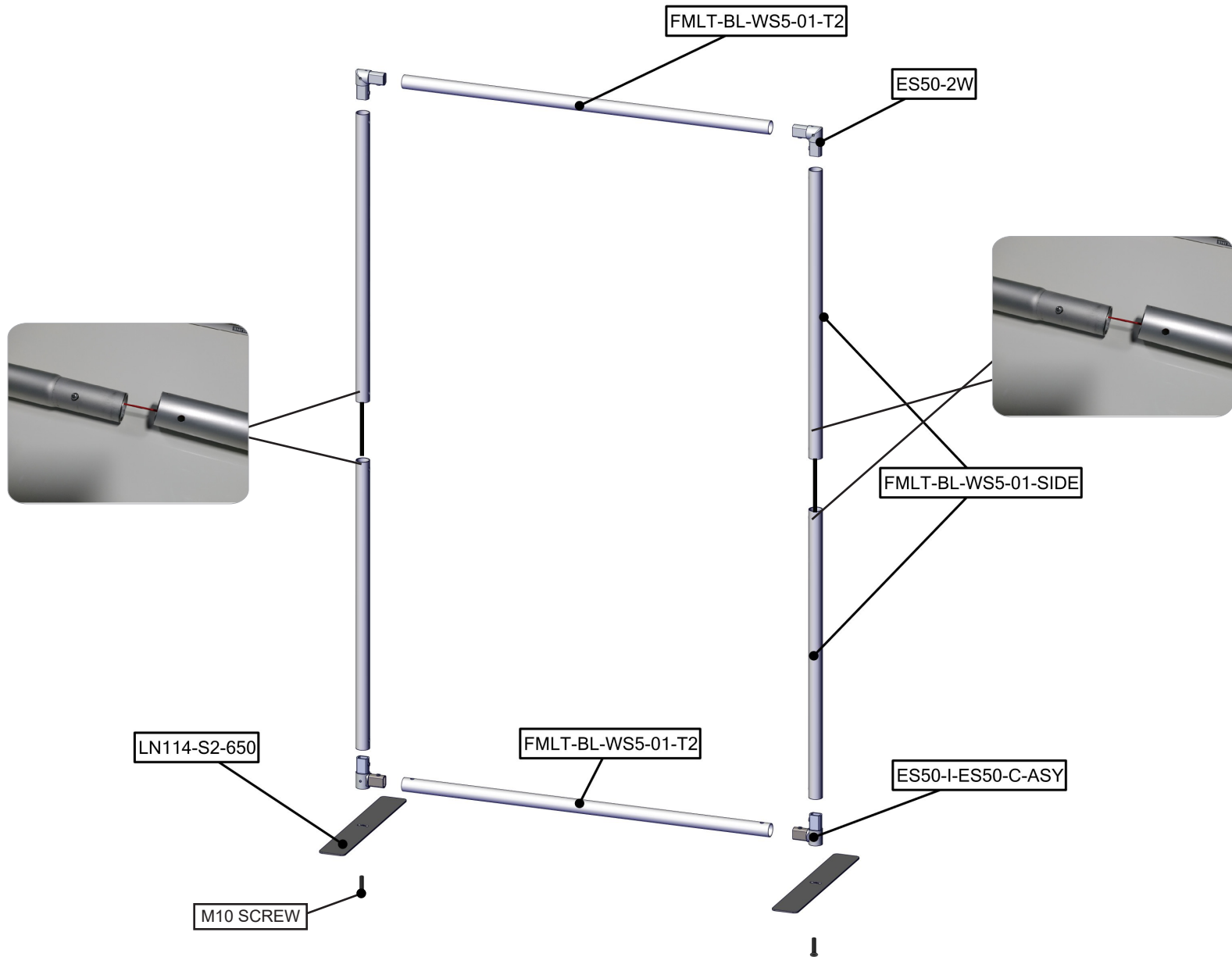

# Labeling Diagram

FMLT-BL-WS5-01

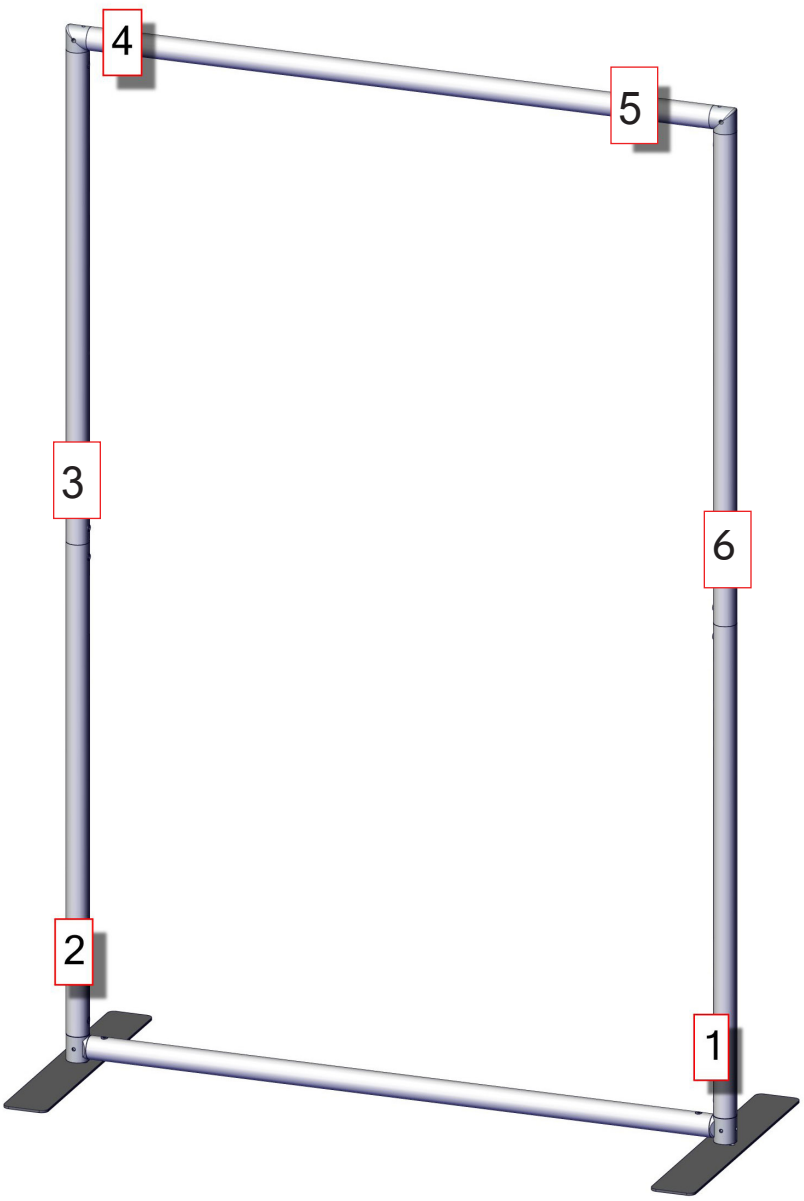

# Connection Methods

## Connection Method 1: ES50-2W

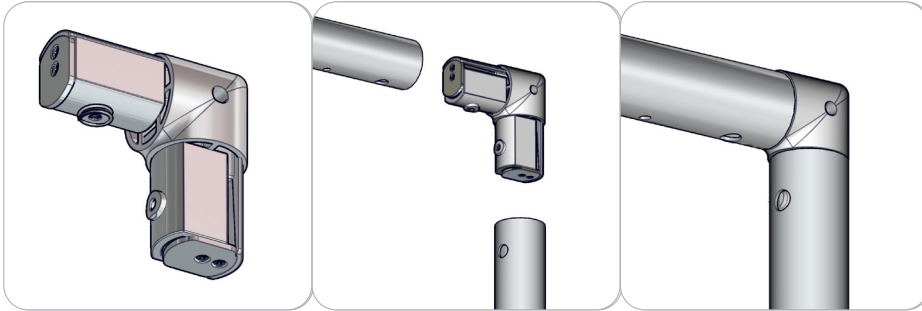

First, check if the connector ends compress. If they do not compress, use the allen key tool for turning the internal screw counter clockwise. Second, compress the connector end and slide it into the tube. Align the connector end button with the tube hole until it pops out. Third, use the allen key tool for turning the internal screw clockwise for a secure fit. Be sure to lock securely, but do not over tighten. Do not force the connection and be careful with the tube edges, they may be sharp. To disassemble, unlocked connector press the snap button and pull apart.

## Connection Method 2: ES50-I-ES50-C-ASY



First, check if the connector ends compress. If they do not compress, use the allen key tool for turning the internal screw counter clockwise. Second, compress the connector end and slide it into the tube. Align the connector end button with the tube hole until it pops out. Third, use the allen key tool for turning the internal screw clockwise for a secure fit. Be sure to lock securely, but do not over tighten. Attach a stabilizing base plate to the connector with a M10 counter sink screw.

## Connection Method 3: SNAP BUTTONS

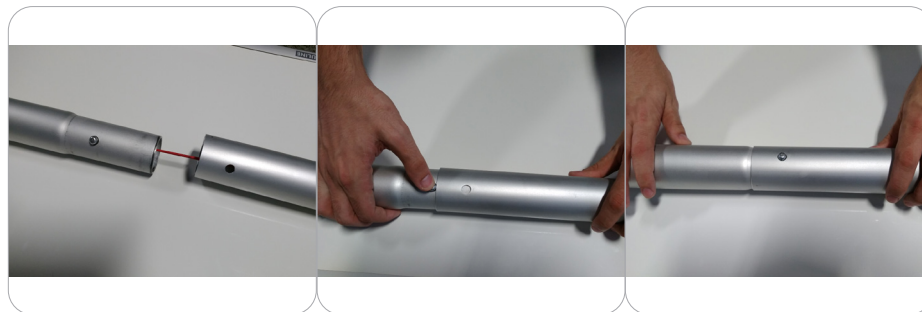

For snap button connections, locate the snap button on the connector or swage tube. Locate the hole on the corresponding tube. Press the snap button with your thumb and slide the tube and connector together so that the snap button snaps fully into the lock hole. To disassemble, press the snap button and pull apart.

# Kit Assembly

## Step by Step

### Step 1.

Step 1: Remove the black, vinyl bag from the shipping case and lay it on the floor.

A. Unzip and remove the bungee connected tubes from the bag and connect the tubes using the push-buttons. See Connection Method 3 for more details.

B. Remove the non-bungeed tubes from the bag and match the labeled numbers to the ends of the tubes that you've already placed on the ground.

See Connection Method 1 for the top of the frame, and Connection Method 2 for the bottom of the frame. Do not tighten down the bottom spigots.

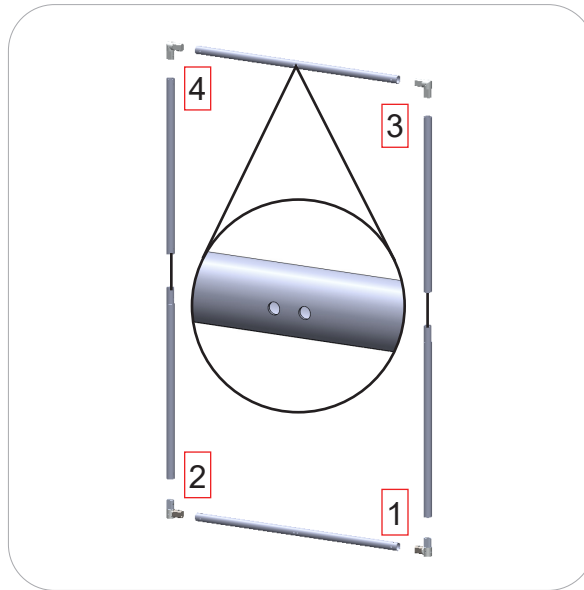

### Step 2.

Attach the feet by removing the bolt from the bottom of the upright tubes, placing the foot against the frame, and inserting the bolt through the foot and into the frame so the bolt head sits in the countersunk hole and is flush with the foot.

Hand tighten and lay the feet so they sit flat against the floor on their side.

Reference Connection Method 2 for more details.

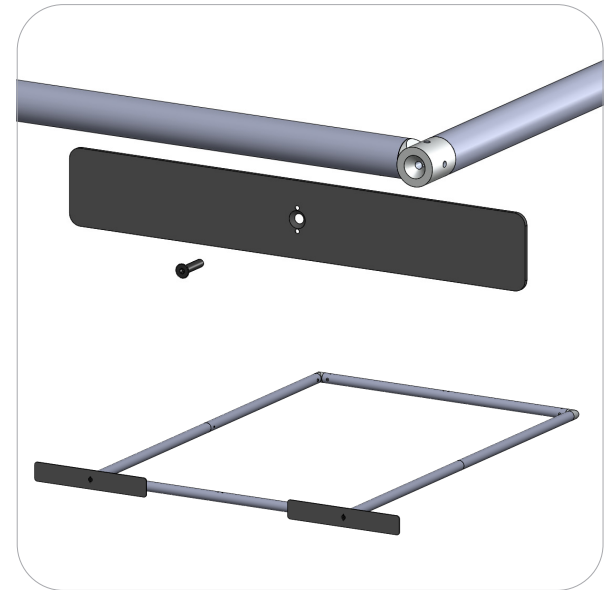

### Step 3.

Remove one of the light curtains from its box and bring it to the frame, padding still in place.

Check the plugs of the curtain; with the male end toward the top of the frame, unroll the curtain with the bulbs facing down.

Be sure to keep the padding and packaging to protect the lights during storage and shipping.



### Step 4.

Hook the light curtain clips into the two holes at the top of the frame closest to the side.



# Kit Assembly

## Step by Step

### Step 5.

Unroll the light curtain and leave the bottom loose.

Repeat Steps 4-6 until all curtains have been hooked to the top of the frame.

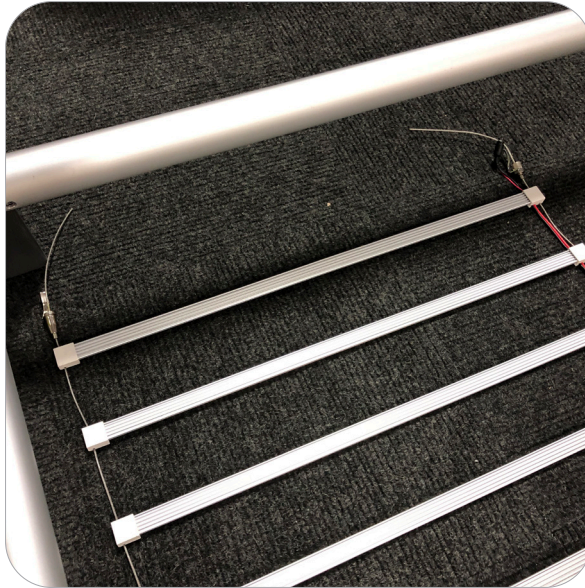
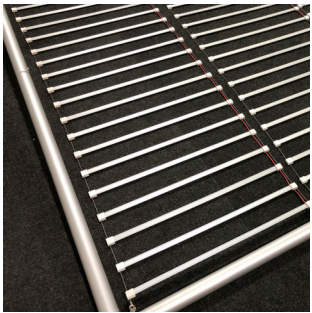

### Step 6.

Verify that the top bar of lights on each curtain at the top of the frame are all level and approximately the same distance from the top of the frame.

Adjust slack in the curtain by pinching the hook button and pulling the cable towards you to tighten or pulling the hook towards you to loosen.

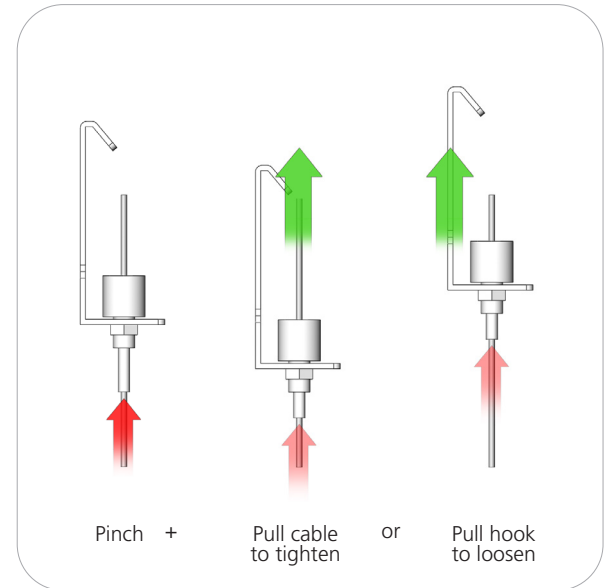

### Step 7.

Insert any excess cable of the light curtains into the hole of its connected hook to prevent it from pushing against the graphic.



### Step 8.

Move to the bottom of the frame and push in the spigot buttons to rotate the tube approximately 1/4 turn so the hook holes are just shy of facing the top of the frame.

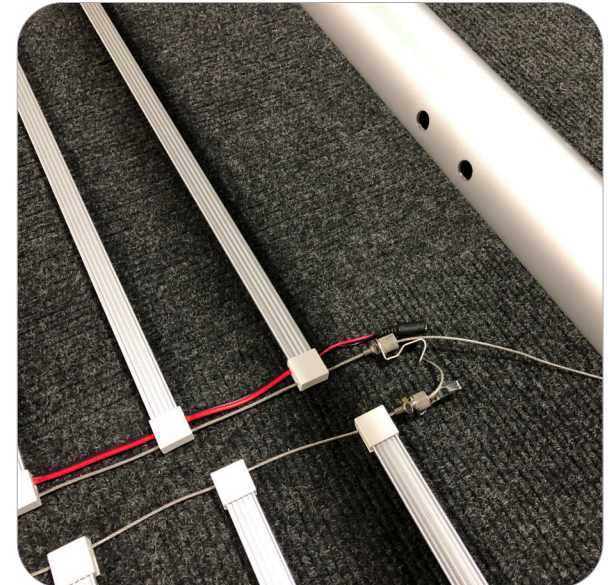

# Kit Assembly

## Step by Step

### Step 9.

Insert the light hooks from the bottom of the curtains and any excess cable into the holes.

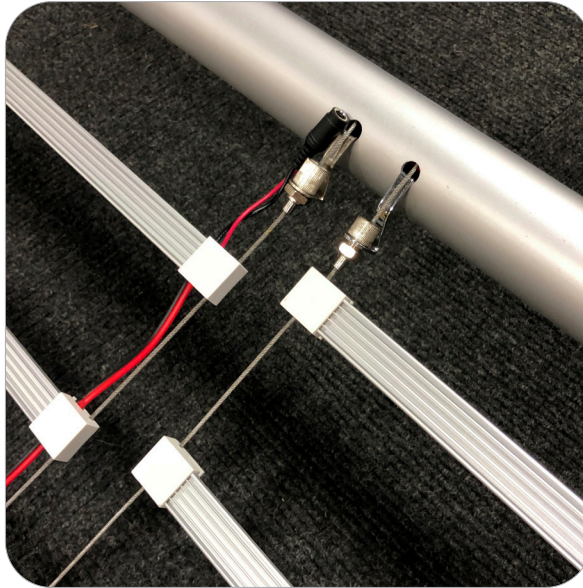

### Step 10.

Rotate the bottom tube back to the original position so the spigot buttons align with the holes.

If the buttons do not want to pop up through the holes, tighten them slightly and line up the spigot button with the hole in the tube;

If the spigot button was loosened completely, they tend to not have enough pressure to push the button through the hole.

Tighten the spigots.

See Connection Method 2 for more details.



### Step 11.

Rotate the feet to their correct, perpendicular orientation.

With the frame still laying on the ground, pull the pillowcase graphic over the top of the frame to begin fitting.

Make sure the graphic is being installed evenly down both sides of the frame.



### Step 12.

Once the graphic has reached 1/4 to 1/2 way down the frame, you can stand the frame upright to assist in installing the graphic the rest of the way down the frame.

Roll up the padding for the lights and store in the light curtain boxes to use during dismantle.





# Kit Assembly

## Step by Step

### Step 13.

Connect the white, male end of the transformer cord into the black, female end of each light curtain's cord.



### Step 14.

Zip the bottom of the graphic; one section for each light curtain.



### Step 15.

Plug in the transformer.

Do not cover or hinder airflow to the transformer as it needs air circulation to work properly.

Set up is complete.

Note: In the US, set the transformer to 115v; anywhere else, set it to 230v.

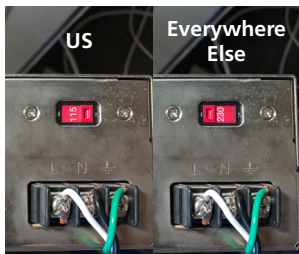

# Kit Assembly

## Step by Step

### Step 1.

Gather the components to build the frame. Use the Exploded View and the Labeling Diagram for part labels.

Reference Connection Method 1 for more details.

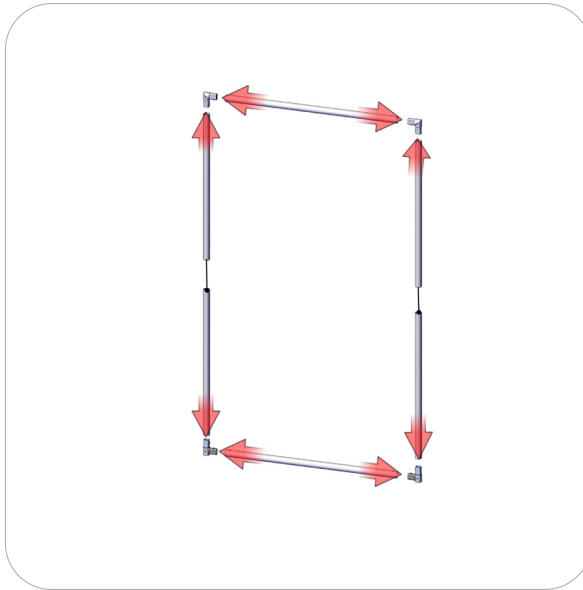

### Step 2.

Gather the components to attach the bases. Use the Exploded View and the Labeling Diagram for part labels.

Reference Connection Method 2 for more details.



### Step 3.

Gather the components to attach the lights. (To Adjust the light clip, pinch and pull towards you to tighten and pull away to loosen.) Use the Exploded View and the Labeling Diagram for part labels.



### Step 4.

Plug power supply to lighting cord. Final set plug in a wall outlet

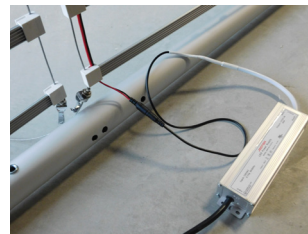

# Kit Assembly

## Step by Step

### Step 5.

Slide graphic over top of frame.  
Once in place the graphic may be zipped at the bottom.

Setup is complete.

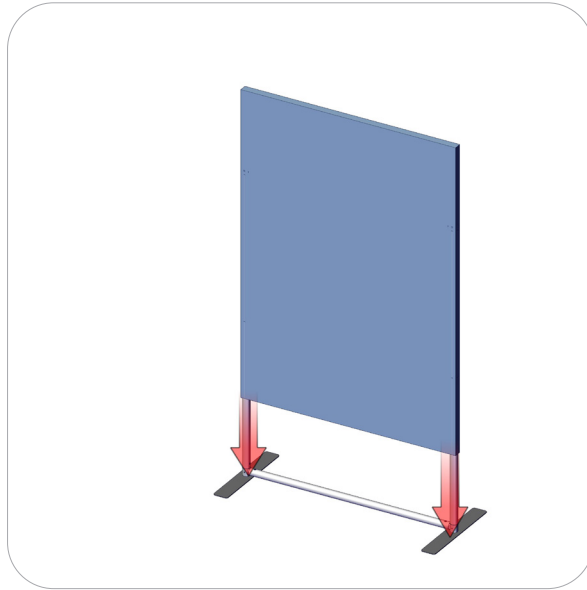
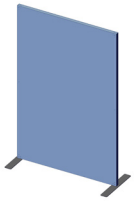

# Kit Assembly

## Step by Step

### Step 1.

Gather the components to build the frame. Use the Exploded View and the Labeling Diagram for part labels.

Reference Connection Method 1 for more details.

Do not lock the bottom tube, and ensure the light mounting holes point upward.

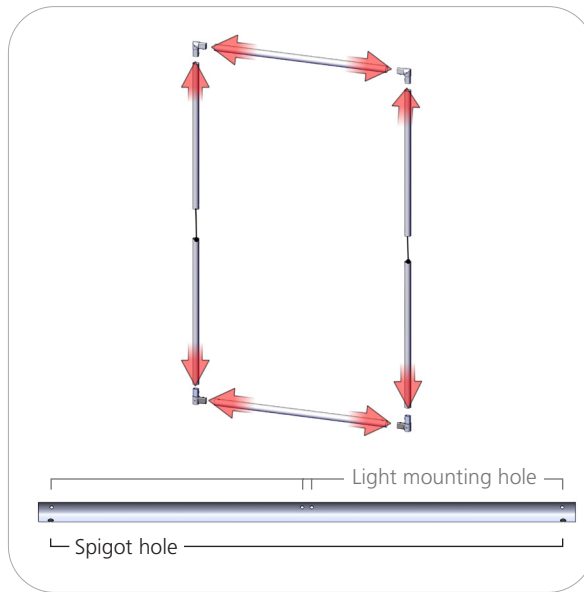

### Step 2.

Gather the components to attach the bases. Use the Exploded View and the Labeling Diagram for part labels.

Reference Connection Method 2 for more details.

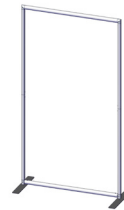

### Step 3.

Hook the lights in the top tube mounting holes to hang, noting top vs. bottom labeling (the female plugs should be on bottom).

Use the Exploded View and the Labeling Diagram for part labels.



### Step 4.

Hook the lights in the bottom tube light mounting holes and rotate the tube so the spigot holes face up and the lock engages through. Tighten in place.

Reference Connection Method 1 for more details.

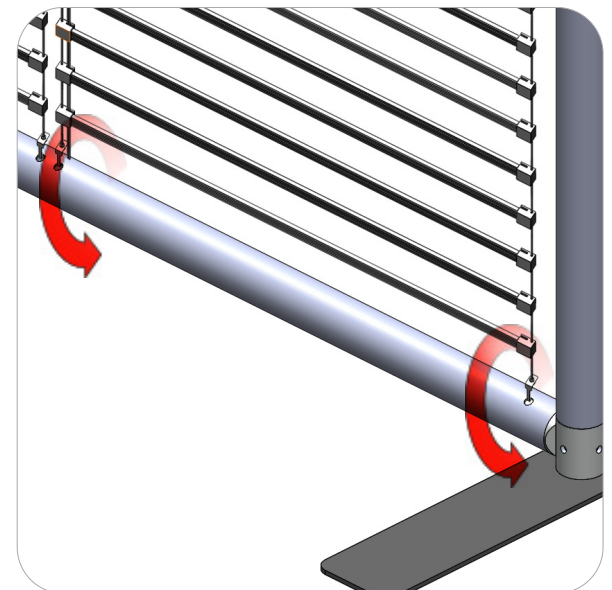
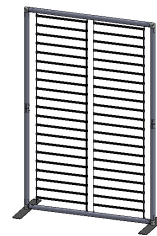

# Kit Assembly

## Step by Step

### Step 4. (Optional)

To correct slack in the curtain, adjust the light hooks by pinching and pulling the cable towards you to tighten or pulling the hook towards you to loosen.

Reference Connection Method 1 for more details.

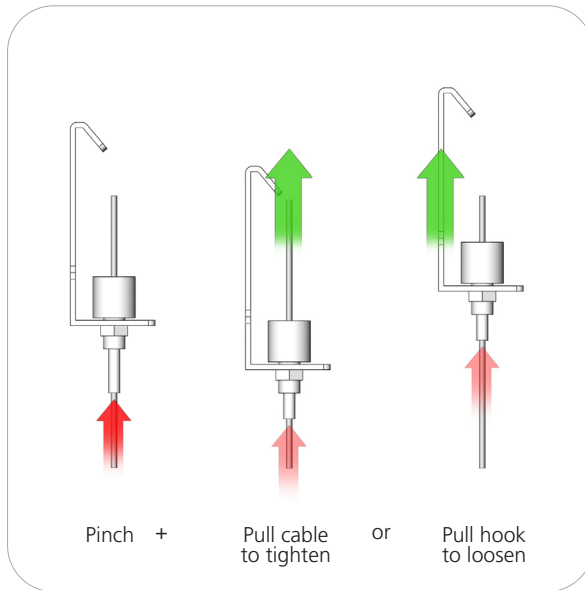
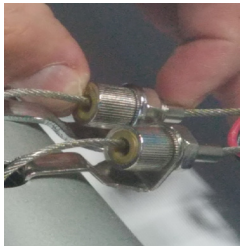

### Step 5.

Plug power supply to lighting cord. Final set plug in a wall outlet

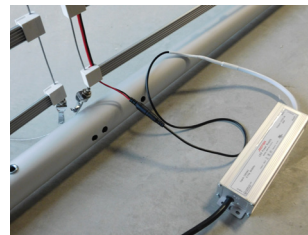

### Step 6.

Slide graphic over top of frame. Once in place the graphic may be zipped at the bottom.

Setup is complete.

