

# 20 Foot Backlit Ensemble Display Assembly Instructions

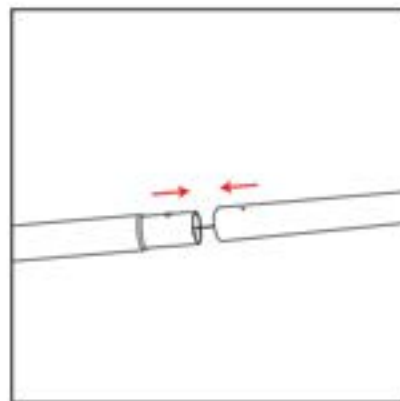

1. Straighten and assemble all bungeed poles.

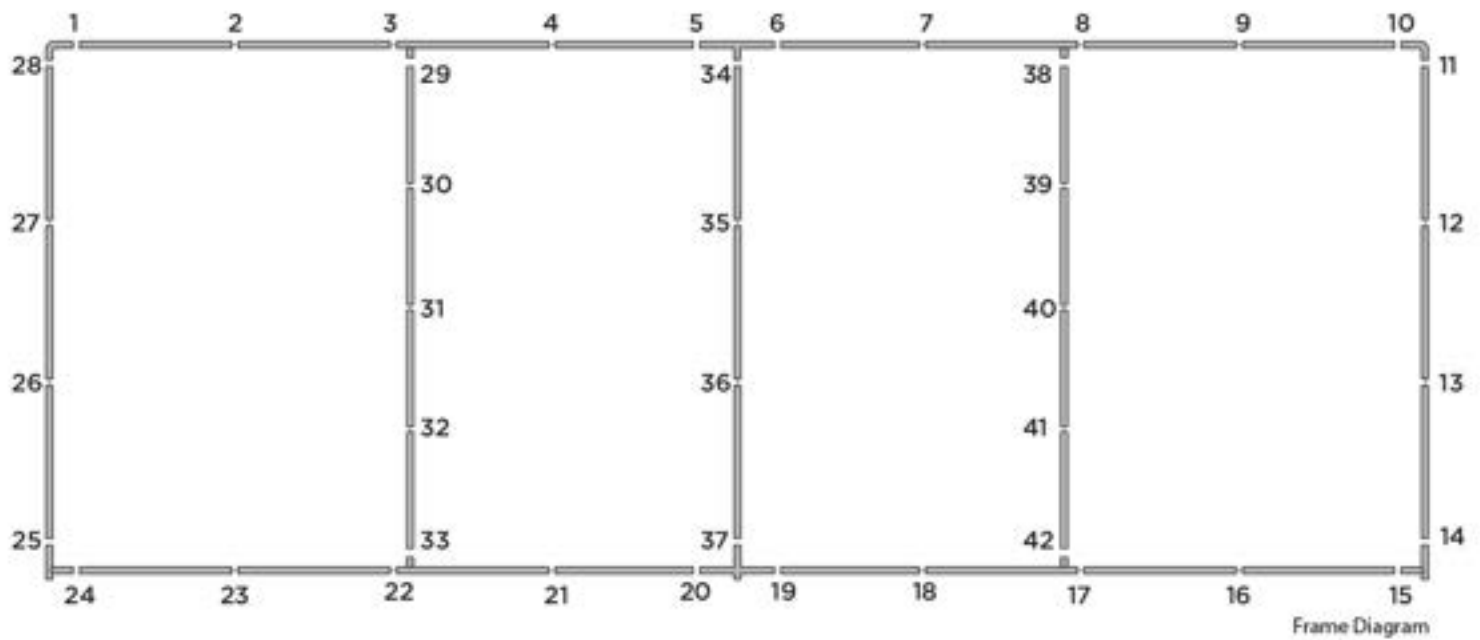
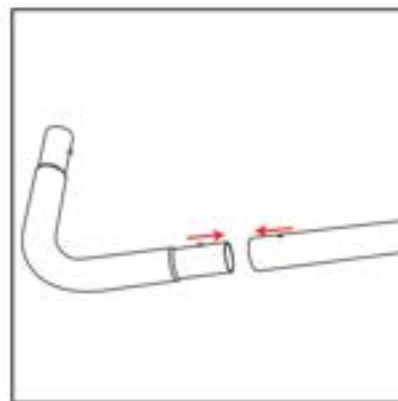

2. Assemble the frame by aligning the stickers as seen in the frame diagram above. Install the support pole.

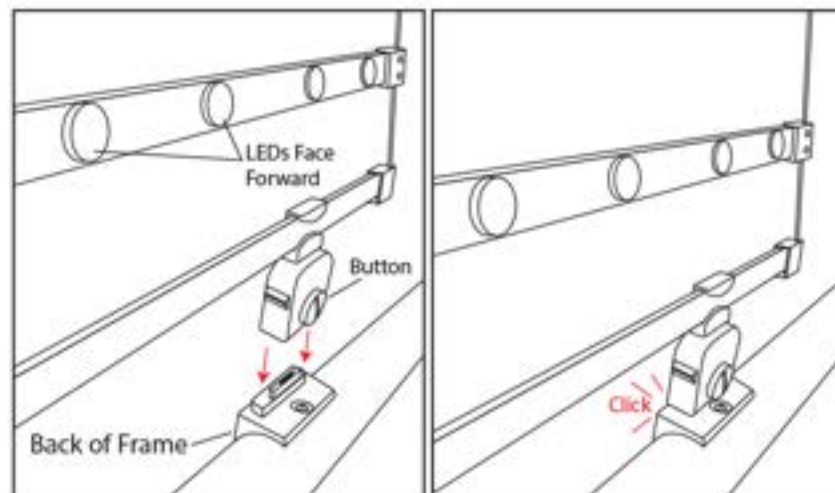

3. Install the four curtain lights by snapping them onto the frame. See diagram above to ensure the LED lights face the correct direction.

# 20 Foot Backlit Ensemble Display Assembly Instructions



4. Pull pillowcase graphic over frame. Do not zip the graphic closed, at this point.

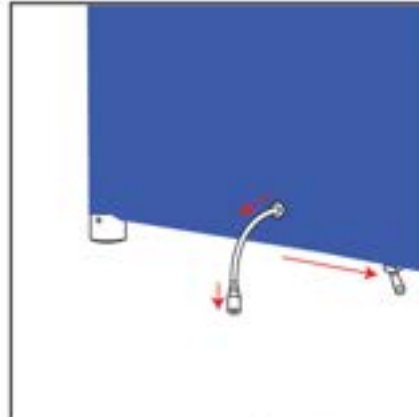

5. Pass power cords through grommets in the back of the graphic and then zip the graphic closed.

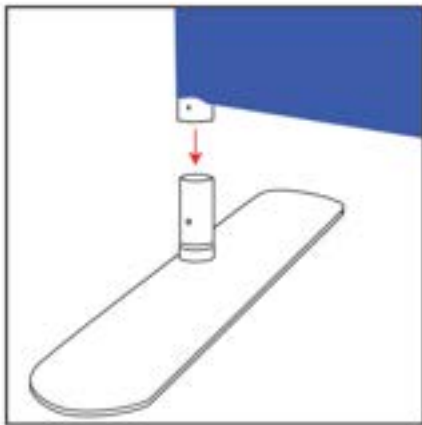

6. Attach the outer feet, Swivel center feet out, and stand the frame up.

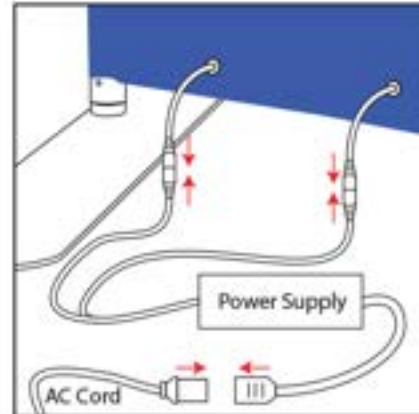

7. Connect the power cords to the power supplies and plug them into an electrical outlet.

